

GENERAL
CATALOGUE

2026 / 2027



BESTILE
Time to Create

BESTILE

Time to Create

At **Bestile**, innovation is part of our DNA. Every day, we set ourselves new challenges to continue advancing in the development of ceramic solutions that combine technology, design and precision.

With a **solid track record in the industry**, we have built a path based on continuous improvement, investment in technology and in-depth product knowledge. Our new general catalogue reflects this commitment: collections created through advanced production processes, where technical control, material research and the evolution of finishes allow us to reach new levels of quality and expression.

Formats, reliefs and surfaces that not only meet the demands of international markets, but anticipate them, offering versatile, competitive solutions ready for any environment.

Pushing boundaries to keep creating.
Evolving to make a difference.



En **Bestile**, la innovación forma parte de nuestro ADN. Cada día nos marcamos nuevos retos para seguir avanzando en el desarrollo de soluciones cerámicas que combinan tecnología, diseño y precisión.

Con una **sólida trayectoria en el sector**, hemos construido un camino basado en la mejora continua, la inversión en tecnología y el conocimiento profundo del producto. Nuestro nuevo catálogo general refleja ese compromiso: colecciones creadas a partir de procesos productivos avanzados, donde el control técnico, la investigación en materiales y la evolución de acabados nos permiten alcanzar nuevos niveles de calidad y expresión.

Formatos, relieves y superficies que no solo responden a las exigencias del mercado internacional, sino que las anticipan, ofreciendo propuestas versátiles, competitivas y preparadas para cualquier entorno.

Superar límites para seguir creando.
Evolucionar para marcar la diferencia.

INNOVATION AND TECHNOLOGY

USE OF ADVANCED TECHNOLOGIES

We employ the most advanced technologies in all our production processes.
Automation and robotics in the production line to ensure precision and efficiency.

INVESTMENT IN R&D

We continuously invest in research and development to improve our products and processes.
We collaborate with research centers and universities to stay at the forefront of ceramic technology.

Design, manufacturing, and 3D printing with AI integration.
Transition to green hydrogen.

COMMITMENT

PERSONALIZED ATTENTION

We strive to understand and meet the specific needs of each customer.
We offer advice and technical support to ensure maximum satisfaction.

LONG-LASTING RELATIONSHIPS

We build relationships based on trust, quality, and innovation.
We strive to offer exceptional after-sales service to maintain customer loyalty.

CHRONOLOGY / CRONOLOGÍA

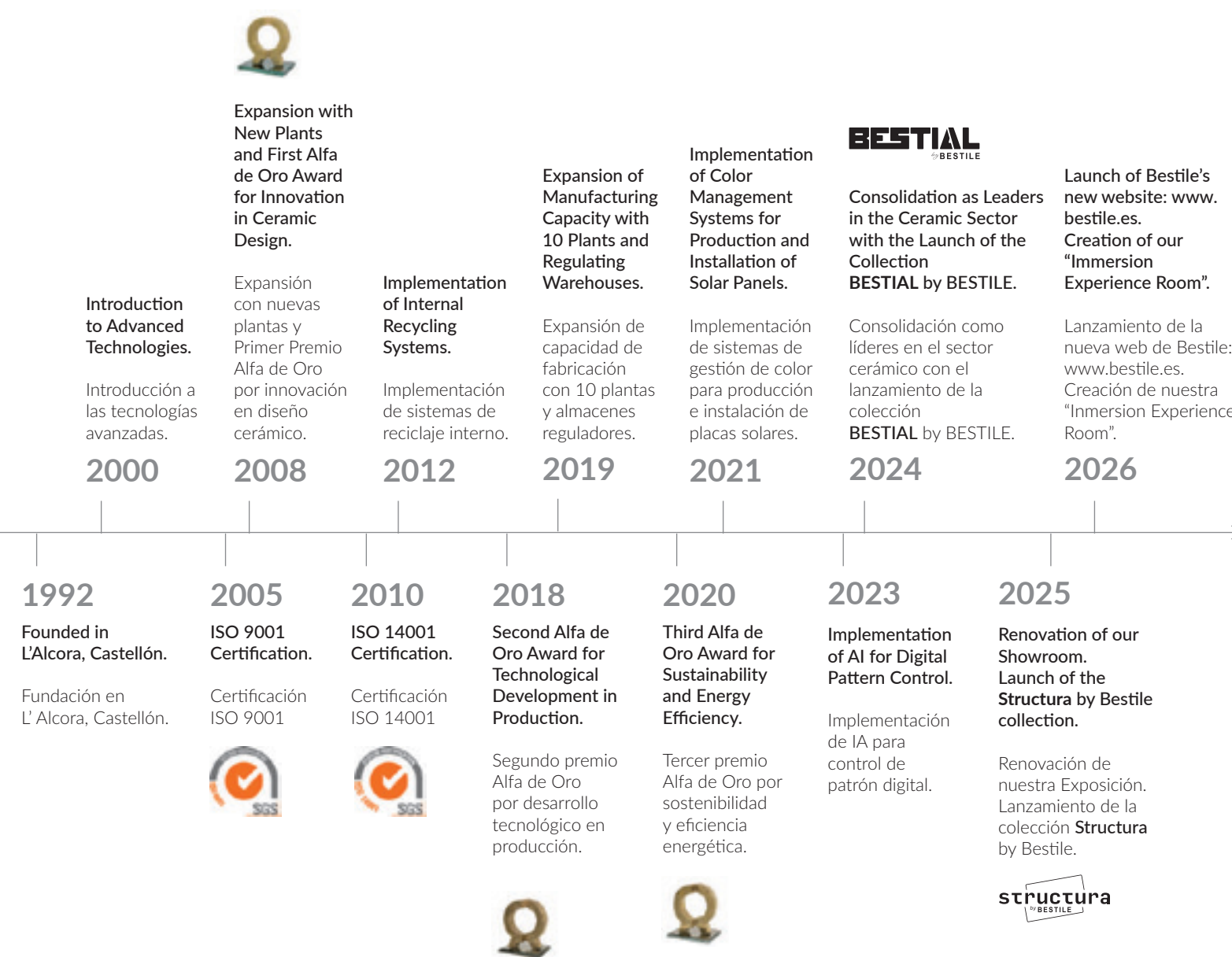

INNOVACIÓN Y TECNOLOGÍA

USO DE TECNOLOGÍAS AVANZADAS

Empleamos las tecnologías más avanzadas en todos nuestros procesos productivos.
Automatización y robótica en la línea de producción para garantizar precisión y eficiencia.

INVERSIÓN EN I+D

Invertimos continuamente en investigación y desarrollo para mejorar nuestros productos y procesos.
Colaboramos con centros de investigación y universidades para mantenernos a la vanguardia de la tecnología cerámica.

Diseño, fabricación e impresión 3D con Integración de IA.
Transición al hidrógeno verde.

COMPROMISO

ATENCIÓN PERSONALIZADA

Nos esforzamos por entender y satisfacer las necesidades específicas de cada cliente.
Ofrecemos asesoramiento y soporte técnico para asegurar la máxima satisfacción.

RELACIONES DURADERAS

Construimos relaciones basadas en la confianza, la calidad y la innovación.
Nos esforzamos en ofrecer un servicio postventa excepcional para mantener la lealtad de nuestros clientes.

FORMAT INDEX_Índice por formato

100x100 cm / 39,4"x39,4"

Balbi	GPR-R	100x100 cm	108
Blesle	GPR-R	100x100 cm	110
Galdar	GPR-R	100x100 cm	112
Sinai	GPR-R	100x100 cm	114

60x120 cm / 23,6"x47,2"

Balbi	GPR-R	60x120 cm	88
Casual	GPR-R	60x120 cm	92
Concept	GPR-R	60x120 cm	94
Galdar	GPR-R	60x120 cm	96
Pulpis	GPR-R	60x120 cm	98
Renzo	GPR-R	60x120 cm	100
Sinclair	GPR-R	60x120 cm	102
Travertino	GPR-R	60x120 cm	106

60x120 cm 14 MM / 23,6"x47,2"x0,6"

Balbi	GPR-R	60x120x1,4 cm	88
Pierre Dot	GPR-R	60x120x1,4 cm	184

60x90 cm / 23,6"x35,4"

Avalon RLV	GPR	60x90 cm	122
Caliza RLV	GPR	60x90 cm	124
Elvas RLV	GPR	60x90 cm	128
Juliette RLV	GPR	60x90 cm	130
Koral RLV	GPR	60x90 cm	132
Naos RLV	GPR	60x90 cm	134
Preston RLV	GPR	60x90 cm	136
Sinai RLV	GPR	60x90 cm	138
Taxos RLV	GPR	60x90 cm	140
Tineo RLV	GPR	60x90 cm	144

60x90 cm 20 MM / 23,6"x35,4"x0,8"

Avalon RLV	GPR	60x90x2 cm	122
Caliza RLV	GPR	60x90x2 cm	124
Juliette RLV	GPR	60x90x2 cm	130
Koral RLV	GPR	60x90x2 cm	132
Taxos RLV	GPR	60x90x2 cm	140

60x60 cm / 23,6"x23,6"

Balbi	GPR-R	60x60 cm	88
Blesle	GPR-R	60x60 cm	90
Casual	GPR-R	60x60 cm	92
Concept	GPR-R	60x60 cm	94
Galdar	GPR-R	60x60 cm	96
Pulpis	GPR-R	60x60 cm	98
Renzo	GPR-R	60x60 cm	100
Sinclair	GPR-R	60x60 cm	102
Terrae	GPR-R	60x60 cm	104
Travertino	GPR-R	60x60 cm	106

60x60 cm 14 MM / 23,6"x23,6"x0,6"

Pierre Dot	GPR-R	60x60x1,4 cm	184
----------------------	-----------------	------------------------	-----

40x60 cm / 15,7"x23,6"

Avalon RLV	GPR	40x60 cm	122
Caliza RLV	GPR	40x60 cm	124
Elvas RLV	GPR	40x60 cm	128
Juliette RLV	GPR	40x60 cm	130
Koral RLV	GPR	40x60 cm	132
Naos RLV	GPR	40x60 cm	134
Preston RLV	GPR	40x60 cm	136
Sinai RLV	GPR	40x60 cm	138
Taxos RLV	GPR	40x60 cm	140
Tineo RLV	GPR	40x60 cm	144

33,3x33,3 cm / 13,1"x13,1"

Caliza RLV	GPR	33,3x33,3 cm	116
Palladio RLV	GPR	33,3x33,3 cm	118
Taxos RLV	GPR	33,3x33,3 cm	120

Step 33x120x1,4 cm / 13"x47,2"x0,6"

Balbi	GPR-R	33x120x1,4 cm	88
Concept	GPR-R	33x120x1,4 cm	94
Galdar	GPR-R	33x120x1,4 cm	96
Pierre Dot	GPR-R	33x120x1,4 cm	184
Pulpis	GPR-R	33x120x1,4 cm	98
Renzo	GPR-R	33x120x1,4 cm	100
Sinclair	GPR-R	33x120x1,4 cm	102
Travertino	GPR-R	33x120x1,4 cm	106

30x120 cm / 11,8"x47,2"

Boiserie	GPR-R	30x120 cm	64
--------------------	-----------------	---------------------	----

30x30 cm / 11,8"x11,8"

Galdar	GPR-R	30x30 cm	76
Iconic	GPR-R	30x30 cm	78
Pulpis	GPR-R	30x30 cm	80
Renzo	GPR-R	30x30 cm	82
Sinclair	GPR-R	30x30 cm	84
Terrae	GPR-R	30x30 cm	86

25x150 cm / 9,8"x59"

Thasos	GPR-R	25x150 cm	164
------------------	-----------------	---------------------	-----

22,5x22,5 cm / 8,9"x8,9"

Arona	GPR	22,5x22,5 cm	52
Bella	GPR	22,5x22,5 cm	54
Carole	GPR	22,5x22,5 cm	56
Hydra	GPR	22,5x22,5 cm	62
Izar	GPR	22,5x22,5 cm	58
Nara	GPR	22,5x22,5 cm	40
Valsain	GPR	22,5x22,5 cm	60

20x120 cm / 7,8"x47,2"

Elegance	GPR-R	20x120 cm	166
Isar	GPR-R	20x120 cm	168

Moneo	GPR-R	20x120 cm	170
Tipuana	GPR-R	20x120 cm	172

20x30 cm 20 MM / 7,8"x11,8"x0,8"

Alsacia	GPR	20x30x2 cm	176
Aran	GPR	20x30x2 cm	178
Pierre	GPR	20x30x2 cm	180
Porfido Tex	GPR	20x30x2 cm	182

20x30 cm 14 MM / 7,8"x11,8"x0,6"

Alsacia	GPR	20x30x1,4 cm	176
Aran	GPR	20x30x1,4 cm	178
Pierre	GPR	20x30x1,4 cm	180
Porfido Tex	GPR	20x30x1,4 cm	182

20x20 cm 20 MM / 7,8"x7,8"x0,8"

Alsacia	GPR	20x20x2 cm	176
Aran	GPR	20x20x2 cm	178
Pierre	GPR	20x20x2 cm	180
Porfido Tex	GPR	20x20x2 cm	182

20x20 cm 14 MM / 7,8"x7,8"x0,6"

Alsacia	GPR	20x20x1,4 cm	176
Aran	GPR	20x20x1,4 cm	178
Pierre	GPR	20x20x1,4 cm	180
Porfido Tex	GPR	20x20x1,4 cm	182

19,8x22,8 cm / 7,8"x8,9"

Meraki	GPR	19,8x22,8 cm	50
------------------	---------------	------------------------	----

17x52 cm / 6,7"x20,5"

Alabama	GPR	17x52 cm	148
Baden	GPR	17x52 cm	150
Bergamot	GPR	17x52 cm	152
Concept	GPR	17x52 cm	154
Galdar	GPR	17x52 cm	156
Hanko	GPR	17x52 cm	158
Milena	GPR	17x52 cm	160

15x15 cm / 5,9"x5,9"

Alma	GPR	15x15 cm	46
Altai	GPR	15x15 cm	68
Atlantico	GPR	15x15 cm	70
Bali	GPR	15x15 cm	72

10x30 cm / 3,9"x11,8"

Alma	GPR	10x30 cm	46
Cocole	GPR	10x30 cm	48

7,5x30 cm / 2,9"x11,8"

Iris	PB	7,5x30 cm	38
----------------	--------------	---------------------	----

Nara	PB	7,5x30 cm	40
Tavira	PB	7,5x30 cm	42
Van	PB	7,5x30 cm	44

6,5x20 cm / 2,6"x7,9"

Lewis	GPR	6,5x20 cm	28
Magnetic	GPR	6,5x20 cm	30
Musa	GPR	6,5x20 cm	32
Nolita	GPR	6,5x20 cm	34
Shade	GPR	6,5x20 cm	36

5x50 cm / 2"x19,7"

Bunbury	GPR	5x50 cm	22
Makalu	GPR	5x50 cm	24
Nervia	GPR	5x50 cm	26

5x25x1,2 cm / 2"x9,8"x0,5"

Ainsa	GPR	5x25x1,2 cm	10
-----------------	---------------	-----------------------	----

5x25 cm / 2"x9,8"

Arlington	GPR	5x25 cm	12
Bunbury	GPR	5x25 cm	22
Downtown	GPR	5x25 cm	14
Mago	GPR	5x25 cm	16
Mailo	GPR	5x25 cm	18
Saona	PB	5x25 cm	20

MULTI 1

Isar	GPR-R	Multi 1	168
----------------	-----------------	-------------------	-----

TECHNICAL INFORMATION_Información Técnica

How to read this catalogue	188
Special pieces 14 & 20 MM	190
Icons meaning	191
Type of layings	192
Installation instructions	196
Cleaning and maintenance instructions	198
CTE. Spanish Building Code	200
Slip resistance	201
Technical features	202
Packing list	203

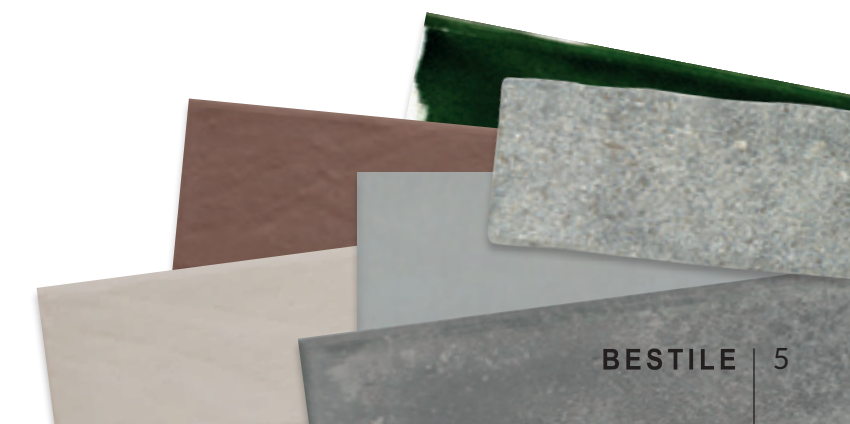

CATEGORY INDEX_Índice por categoría

DECORATIVE

Ainsa	GPR	5x25x1,2 cm	10
Arlington	GPR	5x25 cm	12
Bunbury	GPR	5x25 cm	22
Downtown	GPR	5x25 cm	14
Mago	GPR	5x25 cm	16
Mailo	GPR	5x25 cm	18
Saona	PB	5x25 cm	20
Bunbury	GPR	5x50 cm	22
Makalu	GPR	5x50 cm	24
Nervia	GPR	5x50 cm	26
Lewis	GPR	6,5x20 cm	28
Magnetic	GPR	6,5x20 cm	30
Musa	GPR	6,5x20 cm	32
Nolita	GPR	6,5x20 cm	34
Shade	GPR	6,5x20 cm	36
Iris	PB	7,5x30 cm	38
Nara	PB	7,5x30 cm	40
Tavira	PB	7,5x30 cm	42
Van	PB	7,5x30 cm	44
Alma	GPR	10x30 cm	46
Alma	GPR	15x15 cm	46
Cocole	GPR	10x30 cm	48
Meraki	GPR	19,8x22,8 cm	50
Arona	GPR	22,5x22,5 cm	52
Bella	GPR	22,5x22,5 cm	54
Carole	GPR	22,5x22,5 cm	56
Hydra	GPR	22,5x22,5 cm	62
Izar	GPR	22,5x22,5 cm	58
Nara	GPR	22,5x22,5 cm	40
Valsain	GPR	22,5x22,5 cm	60
Boiserie	GPR-R	30x120 cm	64

POOLS

Altai	GPR	15x15 cm	68
Atlantico	GPR	15x15 cm	70
Bali	GPR	15x15 cm	72

URBAN STYLE

Galdar	GPR-R	30x30 cm	76
Iconic	GPR-R	30x30 cm	78
Pulpis	GPR-R	30x30 cm	80
Renzo	GPR-R	30x30 cm	82
Sinclair	GPR-R	30x30 cm	84
Terrae	GPR-R	30x30 cm	86
Balbi	GPR-R	60x120 cm / 60x60 cm	88
Blesle	GPR-R	60x60 cm	90
Casual	GPR-R	60x120 cm / 60x60 cm	92
Concept	GPR-R	60x120 cm / 60x60 cm	94
Galdar	GPR-R	60x120 cm / 60x60 cm	96
Pulpis	GPR-R	60x120 cm / 60x60 cm	98

Renzo	GPR-R	60x120 cm / 60x60 cm	100
Sinclair	GPR-R	60x120 cm / 60x60 cm	102
Terrae	GPR-R	60x60 cm	104
Travertino	GPR-R	60x120 cm / 60x60 cm	106
Balbi	GPR-R	100x100 cm	108
Blesle	GPR-R	100x100 cm	110
Galdar	GPR-R	100x100 cm	112
Sinai	GPR-R	100x100 cm	114
Caliza RLV	GPR	33,3x33,3 cm	116
Palladio RLV	GPR	33,3x33,3 cm	118
Taxos RLV	GPR	33,3x33,3 cm	120
Avalon RLV	GPR	60x90 cm / 40x60 cm	122
Caliza RLV	GPR	60x90 cm / 40x60 cm	124
Elvas RLV	GPR	60x90 cm / 40x60 cm	128
Juliette RLV	GPR	60x90 cm / 40x60 cm	130
Koral RLV	GPR	60x90 cm / 40x60 cm	132
Naos RLV	GPR	60x90 cm / 40x60 cm	134
Preston RLV	GPR	60x90 cm / 40x60 cm	136
Sinai RLV	GPR	60x90 cm / 40x60 cm	138
Taxos RLV	GPR	60x90 cm / 40x60 cm	140
Tineo RLV	GPR	60x90 cm / 40x60 cm	144

STONE

Alabama	GPR	17x52 cm	148
Baden	GPR	17x52 cm	150
Bergamot	GPR	17x52 cm	152
Concept	GPR	17x52 cm	154
Galdar	GPR	17x52 cm	156
Hanko	GPR	17x52 cm	158
Milena	GPR	17x52 cm	160

WOOD

Thasos	GPR-R	25x150 cm	164
Elegance	GPR-R	20x120 cm	166
Isar	GPR-R	20x120 cm / Multi 1	168
Moneo	GPR-R	20x120 cm	170
Tipuana	GPR-R	20x120 cm	172

TWENTY (20 MM)

Alsacia	GPR	20x20x2 cm, 20x30x2 cm	176
Aran	GPR	20x20x2 cm, 20x30x2 cm	178
Pierre	GPR	20x20x2 cm, 20x30x2 cm	180
Porfido Tex	GPR	20x20x2 cm, 20x30x2 cm	182

FOURTEEN (14 MM)

Alsacia	GPR	20x20x1,4 cm, 20x30x1,4 cm	176
Aran	GPR	20x20x1,4 cm, 20x30x1,4 cm	178
Pierre	GPR	20x20x1,4 cm, 20x30x1,4 cm	180
Porfido Tex	GPR	20x20x1,4 cm, 20x30x1,4 cm	182
Pierre Dot	GPR-R	60x120x1,4 cm / 60x60x1,4 cm	184

ALPHABETICAL INDEX_Índice alfabético

A

Ainsa	GPR	5x25x1,2 cm	10
Alabama	GPR	17x52 cm	148
Alma	GPR	10x30 cm	46
Alma	GPR	15x15 cm	46
Alsacia	GPR	20x20x1,4 cm, 20x30x1,4 cm	176
Alsacia	GPR	20x20x2 cm, 20x30x2 cm	176
Altai	GPR	15x15 cm	68
Aran	GPR	20x20x1,4 cm, 20x30x1,4 cm	178
Aran	GPR	20x20x2 cm, 20x30x2 cm	178
Arlington	GPR	5x25 cm	12
Arona	GPR	22,5x22,5 cm	52
Atlantico	GPR	15x15 cm	70
Avalon RLV	GPR	60x90 cm / 40x60 cm	122

B

Baden	GPR	17x52 cm	150
Balbi	GPR-R	100x100 cm	108
Balbi	GPR-R	60x120 cm / 60x60 cm	88
Bali	GPR	15x15 cm	72
Bella	GPR	22,5x22,5 cm	54
Bergamot	GPR	17x52 cm	152
Blesle	GPR-R	100x100 cm	110
Blesle	GPR-R	60x60 cm	90
Boiserie	GPR-R	30x120 cm	64
Bunbury	GPR	5x25 cm	22
Bunbury	GPR	5x50 cm	22

C

Caliza RLV	GPR	33,3x33,3 cm	116
Caliza RLV	GPR	60x90 cm / 40x60 cm	124
Carole	GPR	22,5x22,5 cm	56
Casual	GPR-R	60x120 cm / 60x60 cm	92
Cocole	GPR	10x30 cm	48
Concept	GPR-R	60x120 cm / 60x60 cm	94
Concept	GPR	17x52 cm	154

D

Downtown	GPR	5x25 cm	14
--------------------	---------------	-------------------	----

E

Elegance	GPR-R	20x120 cm	166
Elvas RLV	GPR	60x90 cm / 40x60 cm	128

G

Galdar	GPR-R	100x100 cm	112
Galdar	GPR-R	30x30 cm	76
Galdar	GPR-R	60x120 cm / 60x60 cm	96
Galdar	GPR	17x52 cm	156

H

Hanko	GPR	17x52 cm	158
Hydra	GPR	22,5x22,5 cm	62

I

Iconic	GPR-R	30x30 cm	78
Iris	PB	7,5x30 cm	38
Isar	GPR-R	20x120 cm / Multi 1	168
Izar	GPR	22,5x22,5 cm	58

J

Juliette RLV	GPR	60x90 cm / 40x60 cm	130
------------------------	---------------	-------------------------------	-----

K

Koral RLV	GPR	60x90 cm / 40x60 cm	132
---------------------	---------------	-------------------------------	-----

L

Lewis	GPR	6,5x20 cm	28
-----------------	---------------	---------------------	----

M

Magnetic	GPR	6,5x20 cm	30
Mago	GPR	5x25 cm	16
Mailo	GPR	5x25 cm	18
Makalu	GPR	5x50 cm	24
Meraki	GPR	19,8x22,8 cm	50
Milena	GPR	17x52 cm	160
Moneo	GPR-R	20x120 cm	170
Musa	GPR	6,5x20 cm	32

N

Naos RLV	GPR	60x90 cm / 40x60 cm	134
Nara	GPR	22,5x22,5 cm	40
Nara	PB	7,5x30 cm,	40
Nervia	GPR	5x50 cm	26
Nolita	GPR	6,5x20 cm	34

P

Palladio RLV	GPR	33,3x33,3 cm	118
Pierre Dot	GPR-R	60x120x1,4 cm / 60x60x1,4 cm	184
Pierre	GPR	20x20x1,4 cm, 20x30x1,4 cm	180
Pierre	GPR	20x20x2 cm, 20x30x2 cm	180
Porfido Tex	GPR	20x20x1,4 cm, 20x30x1,4 cm	182
Porfido Tex	GPR	20x20x2 cm, 20x30x2 cm	182
Preston RLV	GPR	60x90 cm / 40x60 cm	136
Pulpis	GPR-R	30x30 cm	80
Pulpis	GPR-R	60x120 cm / 60x60 cm	98

R

Renzo	GPR-R	30x30 cm	82
Renzo	GPR-R	60x120 cm / 60x60 cm	100

S

Saona	PB	5x25 cm	20
Shade	GPR	6,5x20 cm	36
Sinai	GPR-R	100x100 cm	114
Sinai RLV	GPR	60x90 cm / 40x60 cm	138
Sinclair	GPR-R	30x30 cm	84
Sinclair	GPR-R	60x120 cm / 60x60 cm	102

T

Tavira	PB	7,5x30 cm	42
Taxos RLV	GPR	33,3x33,3 cm	120
Taxos RLV	GPR	60x90 cm / 40x60 cm	140
Terrae	GPR-R	30x30 cm	86
Terrae	GPR-R	60x60 cm	104
Thasos	GPR-R	25x150 cm	164
Tineo RLV	GPR	60x90 cm / 40x60 cm	144
Tipuana	GPR-R	20x120 cm	172
Travertino	GPR-R	60x120 cm / 60x60 cm	106

V

Valsain	GPR	22,5x22,5 cm	60
Van	PB	7,5x30 cm	44

BESTILE
Time to Create

DECORATIVE
Rectified Porcelain Tiles
White Body Tiles &
Porcelain Tiles



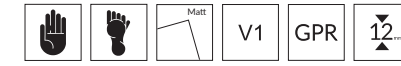

- | | |
|---|---|
|  |  |
| Ainsa Greige | Ainsa Blanco |
|  |  |
| Ainsa Nude | Ainsa Cafe |
|  |  |
| Ainsa Natural | Ainsa Marengo |
|  |  |
| Ainsa Coto | Ainsa Antracita |
|  | |
| Ainsa Caldera | |



Ainsa Coto & Natural

ARLINGTON

PORCELAIN TILES



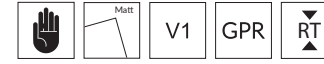

Decorative



Different graphics randomly packaged

Arlington
Porcelain Tiles
5x25 cm
2"x9,8"



- | | |
|---|---|
|  |  |
| Arlington Lino | Arlington Perla |
|  |  |
| Arlington Avena | Arlington Humo |
|  |  |
| Arlington Avellana | Arlington Gris |
|  |  |
| Arlington Indigo | Arlington Antracita |



Arlington Avellana

DOWNTOWN

PORCELAIN TILES

Decorative

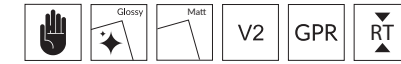

Different graphics randomly packaged

Downtown
Porcelain Tiles

5x25 cm
2"x9,8"



Downtown Matt Blanco

Downtown Matt Rosa

Downtown Matt Beige

Downtown Matt Gris

Downtown Matt Cielo

Downtown Matt Verde

2 Tiles Shown



Downtown Glossy Blanco

Downtown Glossy Rosa

Downtown Glossy Beige

Downtown Glossy Gris

Downtown Glossy Cielo

Downtown Glossy Verde

2 Tiles Shown

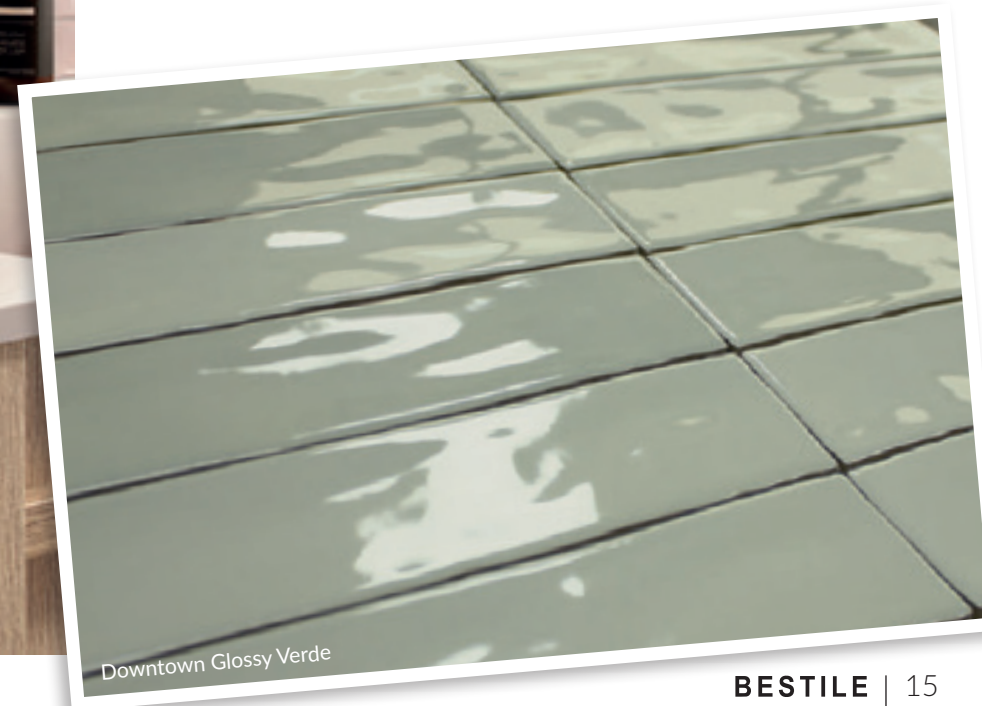

Downtown Glossy Verde

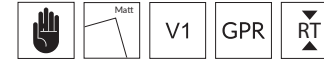

Mago Almond

MAILO

PORCELAIN TILES

Decorative

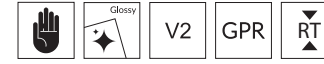









Different graphics randomly packaged

Mailo
Porcelain Tiles

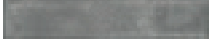
5x25 cm
2"x9,8"

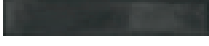

- | | |
|---|---|
|  |  |
| Mailo Blanco | Mailo Beige |
|  |  |
| Mailo Gris | Mailo Cielo |
|  |  |
| Mailo Marengo | Mailo Turquesa |
|  |  |
| Mailo Noir | Mailo Verde |



Mailo Gris

SAONA

WHITE BODY TILES

Decorative

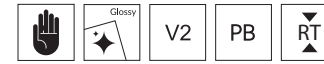

Different graphics randomly packaged

Saona
White Body Tiles

5x25 cm
2"x9,8"



-  Saona White
-  Saona Sky
-  Saona Marine
-  Saona Green



Saona

BUNBURY

PORCELAIN TILES

Decorative

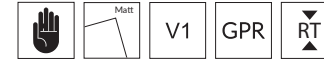

Bunbury
Porcelain Tiles

5x50 cm
2"x19,7"



Bunbury Blanco



Bunbury Greige



Bunbury Cafe



Bunbury Beige



Bunbury Natural



Bunbury Coto



Bunbury Gris



Bunbury Marengo

Bunbury
Porcelain Tiles

5x25 cm
2"x9,8"



Bunbury Blanco



Bunbury Natural



Bunbury Greige



Bunbury Coto



Bunbury Cafe



Bunbury Gris



Bunbury Beige



Bunbury Marengo

MAKALU

PORCELAIN TILES



Makalu Cielo & Makalu Blanco 5x50 cm_2"x19,7"
Makalu Coto Matt 5x50 cm_2"x19,7"



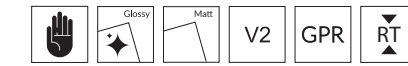











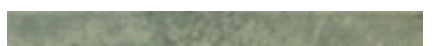



Decorative



Different graphics randomly packaged

Makalu
Porcelain Tiles

5x50 cm
2"x19,7"

- | | |
|---|---|
|  |  |
| Makalu Blanco | Makalu Blanco Matt |
|  |  |
| Makalu Menta | Makalu Menta Matt |
|  |  |
| Makalu Verde | Makalu Verde Matt |
|  |  |
| Makalu Cielo | Makalu Cielo Matt |
|  |  |
| Makalu Azul | Makalu Azul Matt |
|  |  |
| Makalu Perla | Makalu Perla Matt |
|  |  |
| Makalu Beige | Makalu Beige Matt |
|  |  |
| Makalu Coto | Makalu Coto Matt |
|  |  |
| Makalu Salmon | Makalu Salmon Matt |
|  |  |
| Makalu Grana | Makalu Grana Matt |



Makalu Menta Matt

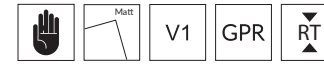

Nervia Matt Linen



Nervia Matt Almond



Nervia Matt Olive



Nervia Matt Berry



Nervia Matt Ice



Nervia Matt Navy



Nervia Matt Ice



Different graphics randomly packaged



Lewis Blanco

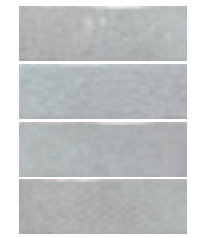

Lewis Perla

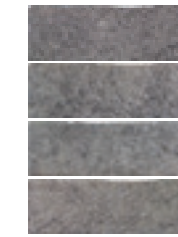

Lewis Grafito



Lewis Arena

4 Tiles Shown



Lewis Perla

MAGNETIC

PORCELAIN TILES

Decorative



Different graphics randomly packaged

Magnetic
Porcelain Tiles
6,5x20 cm
2,6"x7,9"



Magnetic Etereo



Magnetic Tomillo

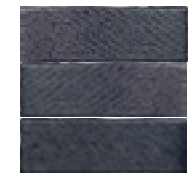

Magnetic Indigo

3 Tiles Shown



Magnetic Tomillo

Decorative

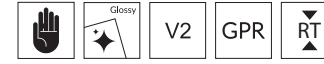

Different graphics randomly packaged

Musa
Porcelain Tiles
6,5x20 cm
2,6"x7,9"



Musa Blanco



Musa Gris



Musa Beige



Musa Oliva



Musa Ocre



Musa Marron



Musa Cielo



Musa Antracita

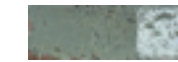

Musa Turquesa



Musa Gris



Different graphics randomly packaged



Special Pieces

Jolly Nolita PB
1,5x20 cm _0,6"x7,9"

- Blanco
- Beige
- Gris
- Rosa
- Burdeos
- Cielo
- Marine
- Verde
- Noir



Nolita Blanco



Nolita Cielo



Nolita Beige



Nolita Marine



Nolita Gris

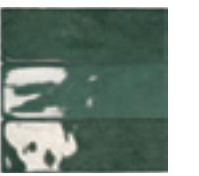

Nolita Verde



Nolita Rosa

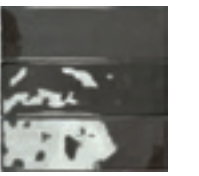

Nolita Noir

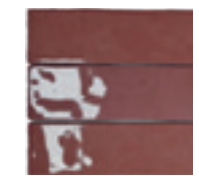

Nolita Burdeos

3 Tiles Shown

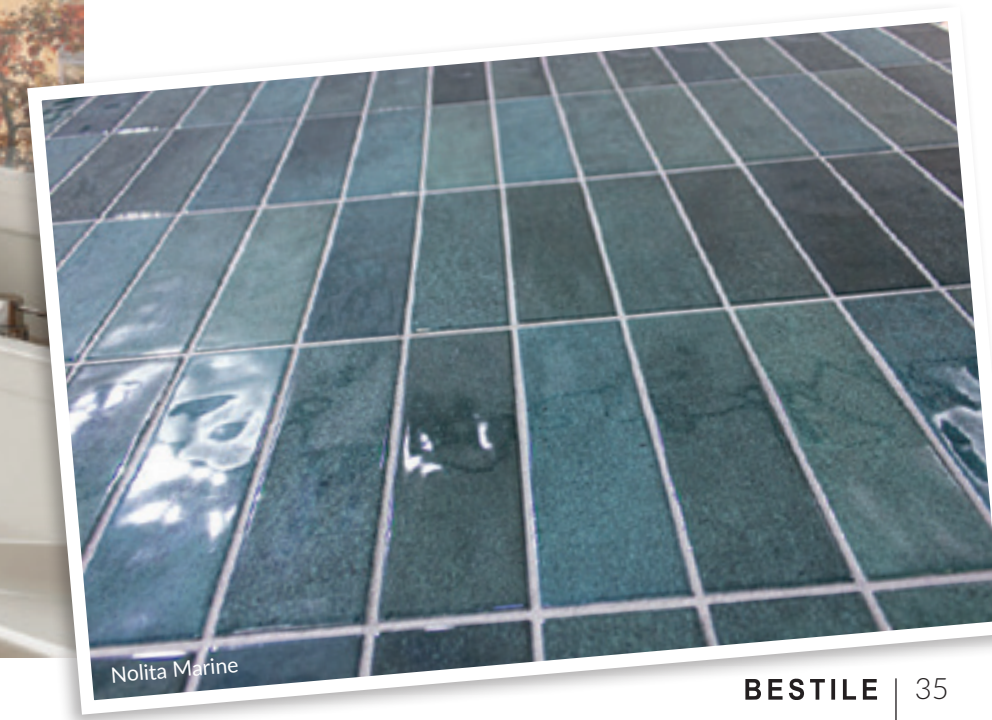

Nolita Marine

SHADE

PORCELAIN TILES

Decorative

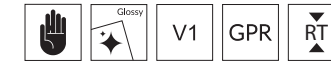

Different graphics randomly packaged

Shade
Porcelain Tiles
6,5x20 cm
2,6"x7,9"



- | | |
|--|--|
|  |  |
| Shade Ocre | Shade Ocre Base |
|  |  |
| Shade Beige | Shade Beige Base |
|  |  |
| Shade Gris | Shade Gris Base |
|  |  |
| Shade Humo | Shade Humo Base |
|  |  |
| Shade Azul | Shade Azul Base |
|  |  |
| Shade Turquesa | Shade Turquesa Base |
|  |  |
| Shade Rosa | Shade Rosa Base |

The partly handcrafted method of production causes shade variation and beautifully imperfect effect.



Shade Humo & Shade Humo Base

IRIS

WHITE BODY TILES

Decorative

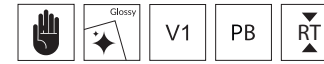

Different graphics randomly packaged

Iris
White Body Tiles

7,5x30 cm
2,9"x11,8"



Iris Blanco



Iris Gris



Iris Beige



Iris Aguamarina



Iris Marron



Iris Azul



Iris Blanco

NARA

WHITE BODY TILES

Decorative

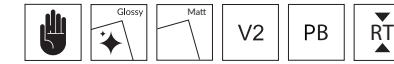













Different graphics randomly packaged

Nara
White Body Tiles

7,5x30 cm
2,9"x11,8"

Also available in size 22,5x22,5 cm_8,9"x8,9" GPR



				Special Pieces 1,5x30 cm_0,6"x11,8"
Nara Blanco	Nara Mostaza	Nara Mostaza Mate	Jolly Nara Blanco	
Nara Mostaza	Nara Burdeos	Nara Burdeos Mate	Jolly Nara Mostaza	
Nara Burdeos	Nara Gris	Nara Gris Mate	Jolly Nara Burdeos	
Nara Gris	Nara Glass	Nara Glass Mate	Jolly Nara Gris	
Nara Glass	Nara Mar	Nara Mar Mate	Jolly Nara Glass	
Nara Mar	Nara Pacifico	Nara Pacifico Mate	Jolly Nara Mar	
Nara Pacifico	Nara Oliva	Nara Oliva Mate	Jolly Nara Pacifico	
Nara Oliva	Nara Noir	Nara Noir Mate	Jolly Nara Oliva	
Nara Noir			Jolly Nara Noir	



TAVIRA

WHITE BODY TILES

Decorative

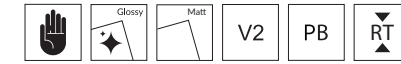





















Different graphics randomly packaged

Tavira
White Body Tiles

7,5x30 cm
2,9"x11,8"



- | | | | |
|---|---|---|---|
|  |  |  |  |
| | Tavira Glossy Etereo | Tavira Matt Etereo | |
| |  |  | |
| | Tavira Glossy Pearl | Tavira Matt Pearl | |
| |  |  | |
| | Tavira Glossy Cream | Tavira Matt Cream | |
| |  |  | |
| | Tavira Glossy Polvo | Tavira Matt Polvo | |
| |  |  | |
| | Tavira Glossy Aire | Tavira Matt Aire | |
| |  |  | |
| | Tavira Glossy Cielo | Tavira Matt Cielo | |
| |  |  | |
| | Tavira Glossy Marino | Tavira Matt Marino | |
| |  |  | |
| | Tavira Glossy Romero | Tavira Matt Romero | |
| |  |  | |
| | Tavira Glossy Noir | Tavira Matt Noir | |

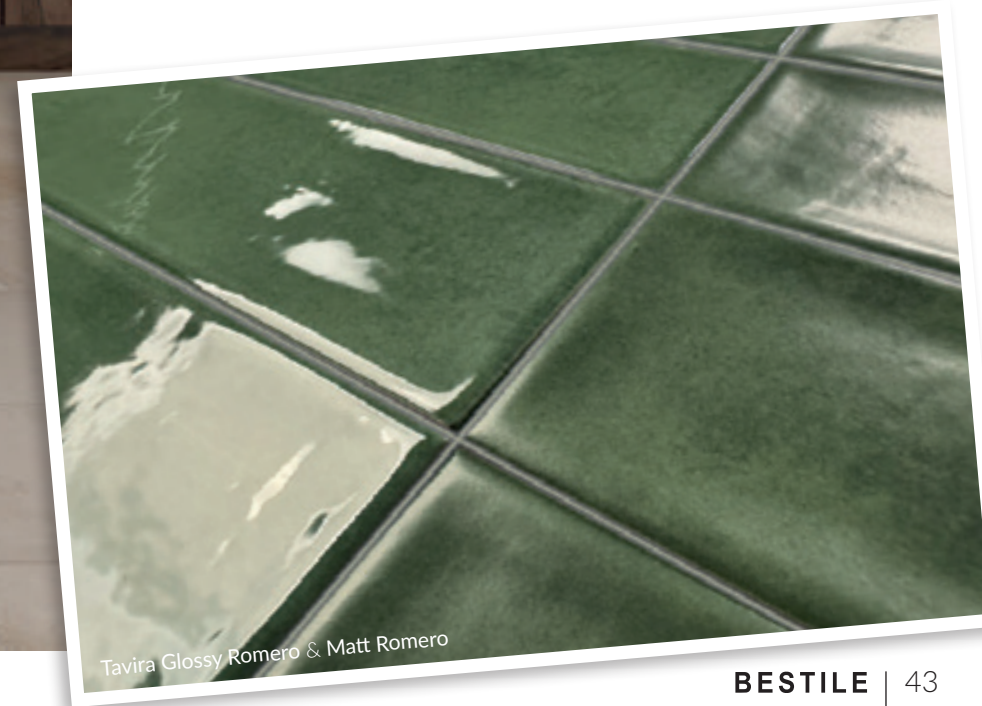

Tavira Glossy Romero & Matt Romero

VAN

WHITE BODY TILES



Van Blanco 7,5x30 cm_2,9"x11,8"
 Van Azul & Van Azul Base 7,5x30 cm_2,9"x11,8"



Van Verde & Van Verde Base 7,5x30 cm_2,9"x11,8"
 Van Beige & Van Beige Base 7,5x30 cm_2,9"x11,8"

Decorative

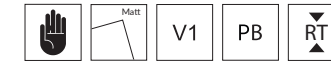

Van
 White Body Tiles
 7,5x30 cm
 2,9"x11,8"



Van Oliva & Van Oliva Base 7,5x30 cm_2,9"x11,8"

Van Beige & Van Beige Base

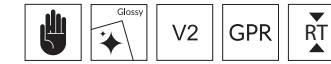

Different graphics randomly packaged

15x15 cm | 10x30 cm
5,9"x5,9" | 3,9"x11,8"

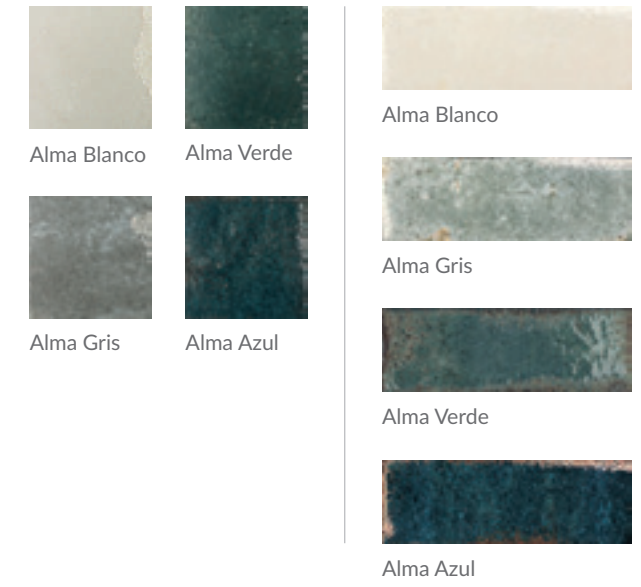

COCOLE

PORCELAIN TILES

Decorative

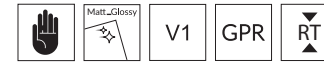

Different graphics randomly packaged

Cocole
Porcelain Tiles
10x30 cm
3,9"x11,8"



Cocole Blanco

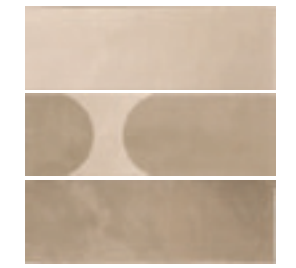

Cocole Beige



Cocole Perla

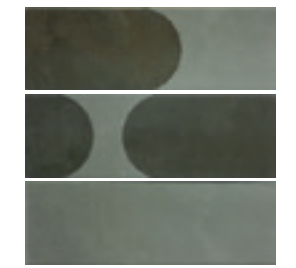

Cocole Oliva



Cocole Gris



Cocole Marino

3 Tiles Shown



Cocole Beige

MERAKI

PORCELAIN TILES

Decorative

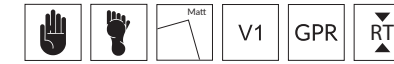

Different graphics randomly packaged

Meraki
Porcelain Tiles

19,8x22,8 cm
7,8"x8,9"



Meraki Rosa



Meraki Mostaza



Meraki Verde

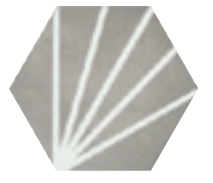

Meraki Gris



Meraki Aguamarina



Meraki Negro



Meraki Azul



Meraki Aguamarina

ARONA

PORCELAIN TILES

Decorative

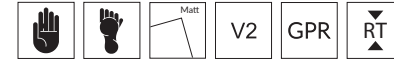

Different graphics randomly packaged

Arona
Porcelain Tiles

22,5x22,5 cm
8,9"x8,9"

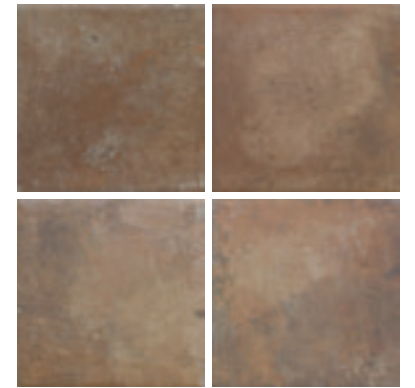

Arona Natural Matt



Arona Gris Matt

4 Tiles Shown



Arona Natural Matt

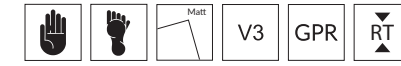

Different graphics randomly packaged

22,5x22,5 cm
8,9"x8,9"

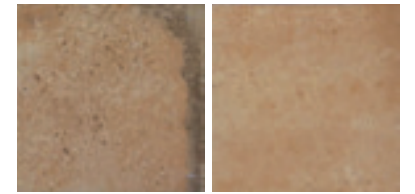

Bella Lino Matt

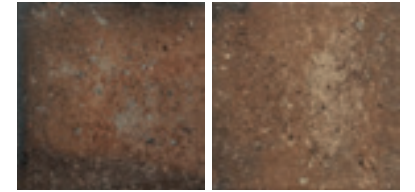

Bella Coto Matt

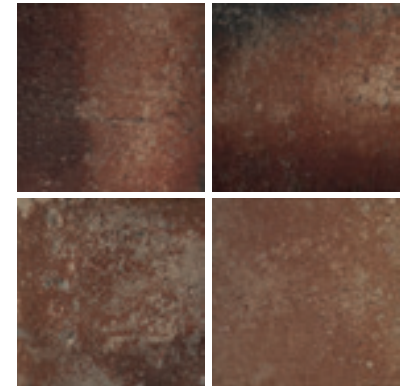

Bella Caldera Matt

2 & 4 Tiles Shown



Bella Lino Matt

CAROLE

PORCELAIN TILES

Decorative

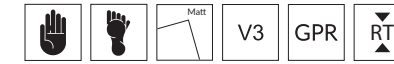

Different graphics randomly packaged

Carole
Porcelain Tiles

22,5x22,5 cm
8,9"x8,9"



Carole Noce Matt

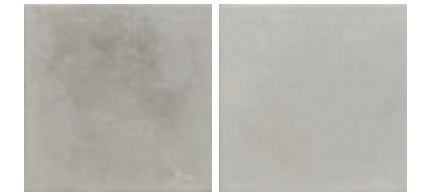

Carole Ice Matt

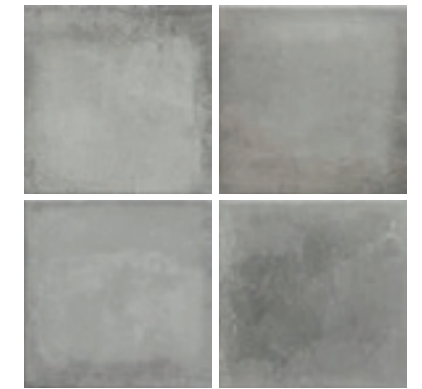

Carole Grey Matt

2 & 4 Tiles Shown



Carole Noce Matt

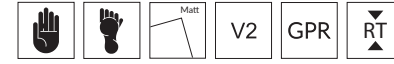

Different graphics randomly packaged

22,5x22,5 cm
8,9"x8,9"

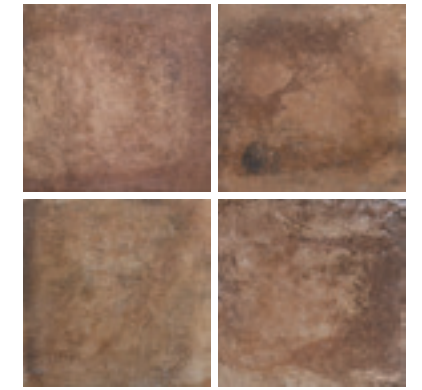

Izar Coto Matt

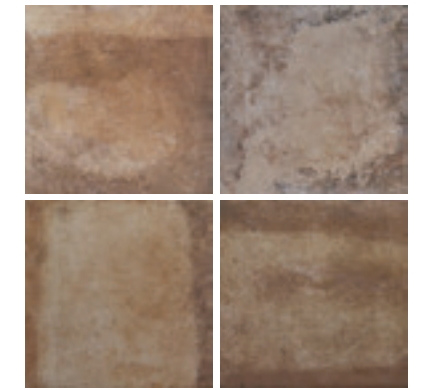

Izar Natural Matt

4 Tiles Shown



Izar Coto Matt

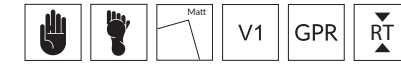

Different graphics randomly packaged

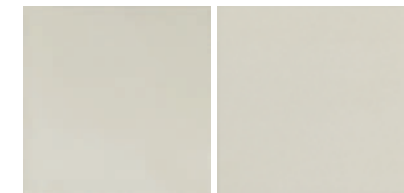

Valsain Marfil



Valsain Arena

Valsain Star Arena



Valsain Coto

Valsain Star Coto

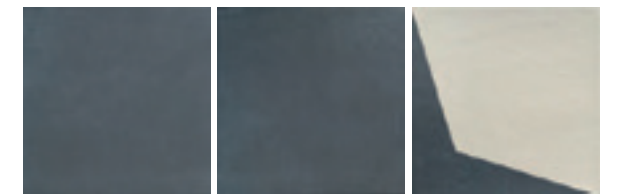

Valsain Azul

Valsain Star Azul

2 Tiles Shown



Valsain Azul & Valsain Star Azul

HYDRA

PORCELAIN TILES

Decorative

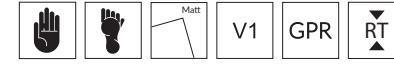

Different graphics randomly packaged

Hydra
Porcelain Tiles

22,5x22,5 cm
8,9"x8,9"

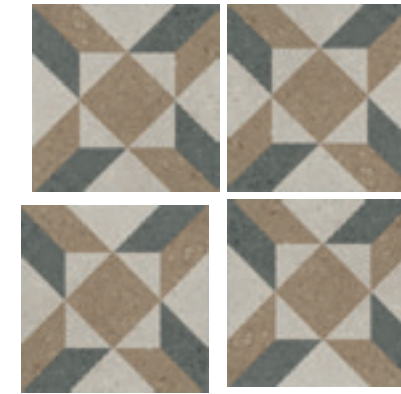

Hydra 01



Hydra 02

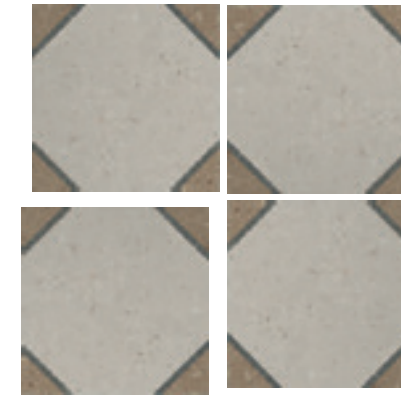

Hydra 03

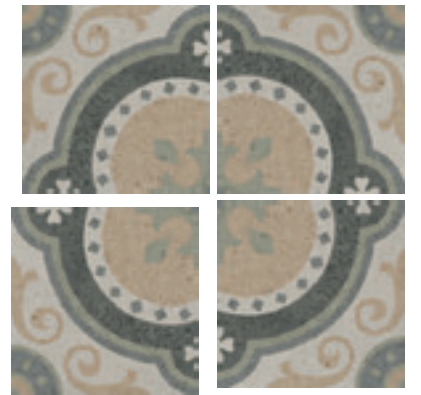

Hydra 04



Hydra 05



Hydra 06

4 Tiles Shown

Recommended joint width: 1.5 mm.
Junta recomendada: 1,5 mm.

Combines with *Galdar*.

BOISERIE

RECTIFIED PORCELAIN TILES



Boiserie Tomillo 30x120 cm_11,8"x47,2" & Chair Rail Tomillo 7x30 cm_2,7"x11,8" & Elegance Roble 20x120 cm_7,8"x47,2"
 Boiserie Etereo 30x120 cm_11,8"x47,2" & Chair Rail Etereo 7x30 cm_2,7"x11,8" & Isar Arce 20x120 cm_7,8"x47,2"

Decorative

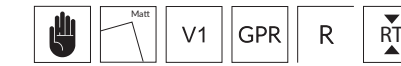

Boiserie
Rectified Porcelain Tiles

30x120 cm
11,8"x47,2"



Boiserie Etereo



Boiserie Aire

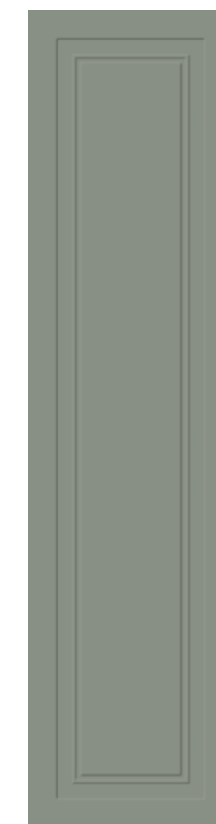

Boiserie Tomillo



Boiserie Indigo



Special Pieces PB

Chair Rail
7x30 cm_2,7"x11,8"



Etereo



Aire

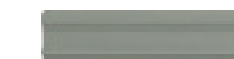

Tomillo



Indigo



Natural



Polvo



Sombra



Boiserie Natural

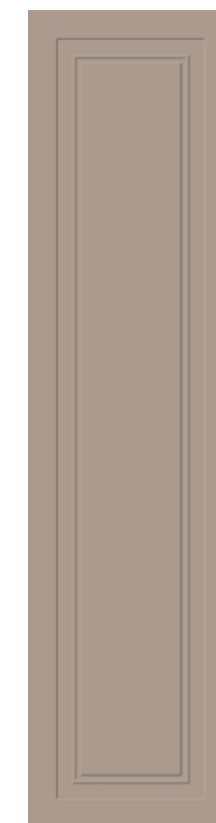

Boiserie Polvo



Boiserie Sombra

BESTILE
Time to Create

POOLS
Porcelain Tiles



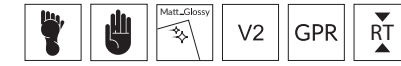

Different graphics randomly packaged

15x15 cm
5,9"x5,9"



Altai White



Altai Green

3 Tiles Shown



Altai Green

ATLANTICO

PORCELAIN TILES

Pools

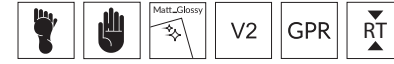

Different graphics randomly packaged

Atlantico
Porcelain Tiles

15x15 cm
5,9"x5,9"



Atlantico Turquoise

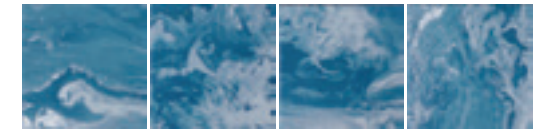

Atlantico Mix

4 Tiles Shown

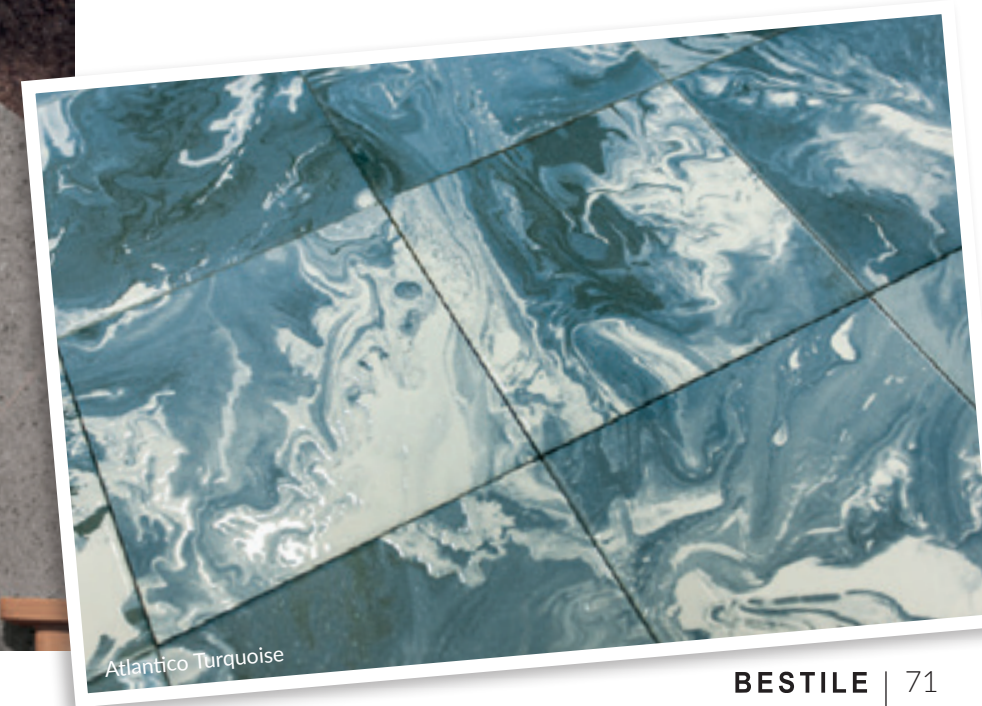

Atlantico Turquoise

BALI

PORCELAIN TILES

Pools

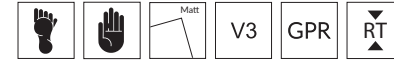

Different graphics randomly packaged

Bali
Porcelain Tiles

15x15 cm
5,9"x5,9"

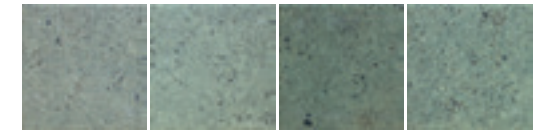

Bali Green



Bali Grey

4 Tiles Shown



Bali Grey

BESTILE
Time to Create

URBAN STYLE
*Porcelain Tiles &
Rectified Porcelain Tiles*



GALDAR

RECTIFIED PORCELAIN TILES

Urban Style

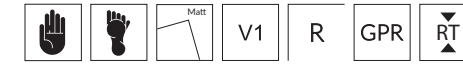

Different graphics randomly packaged

Galdar
Rectified Porcelain Tiles

30x30 cm
11,8"x11,8"



Available Sizes / Tamaños Disponibles

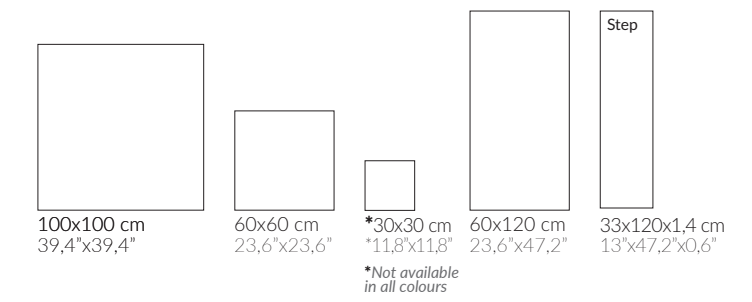

Available Colours / Colores Disponibles

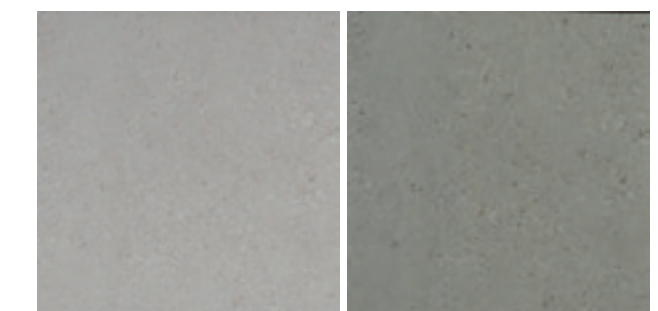

Galdar Lino

Galdar Tomillo

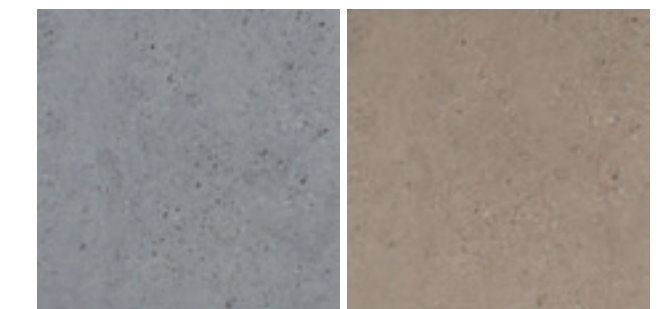

Galdar Humo

Galdar Avena



Galdar Acero

Galdar Avellana

ICONIC

RECTIFIED PORCELAIN TILES

Urban Style

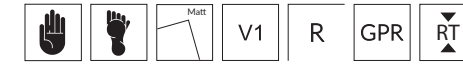

Different graphics randomly packaged

Iconic
Rectified Porcelain Tiles

30x30 cm
11,8"x11,8"



Available Sizes / Tamaños Disponibles



30x30 cm
11,8"x11,8"

Available Colours / Colores Disponibles

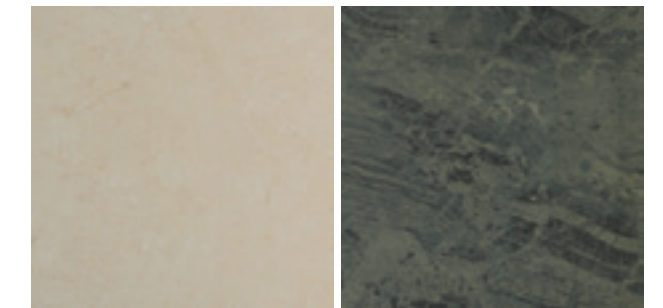

Iconic Cream

Iconic Green

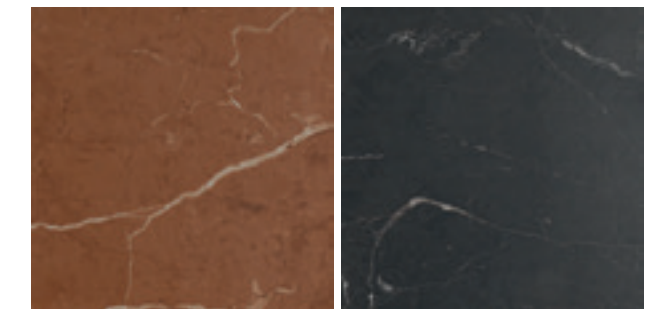

Iconic Red

Iconic Noir

Combines with **Sinclair** 30x30 cm_11,8"x11,8"



Iconic Green & Cream

PULPIS

RECTIFIED PORCELAIN TILES

Urban Style

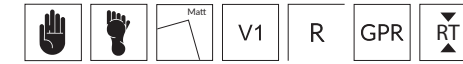

Different graphics randomly packaged

Pulpis
Rectified Porcelain Tiles

30x30 cm
11,8"x11,8"



Available Sizes / Tamaños Disponibles

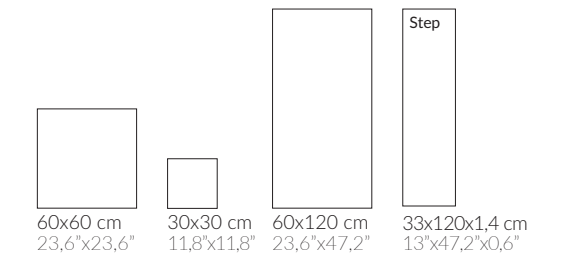

Available Colours / Colores Disponibles



Pulpis Sand

Pulpis Taupe



Pulpis Sand

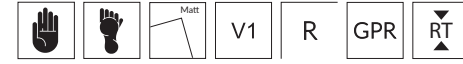

Available Sizes / Tamaños Disponibles

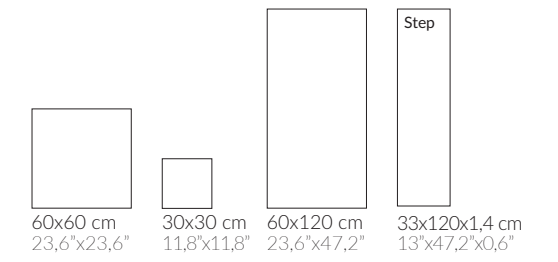

Available Colours / Colores Disponibles

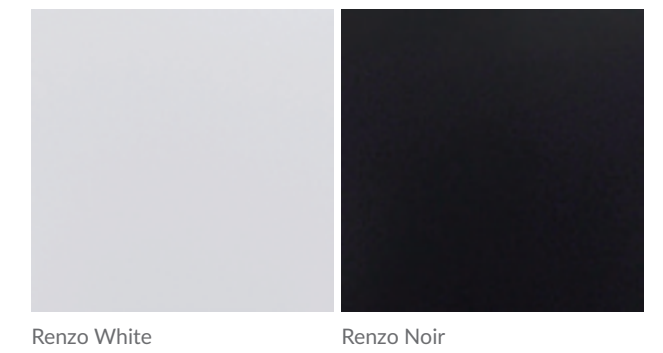

Renzo White & Noir

SINCLAIR

RECTIFIED PORCELAIN TILES

Urban Style

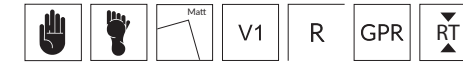

Different graphics randomly packaged

Sinclair
Rectified Porcelain Tiles

30x30 cm
11,8"x11,8"



Available Sizes / Tamaños Disponibles

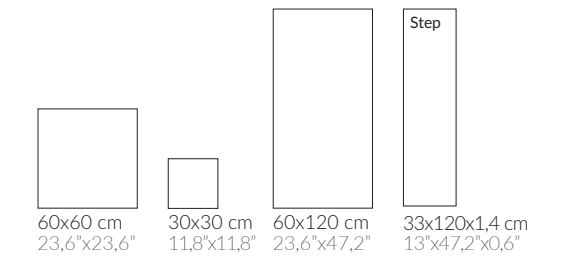

Available Colours / Colores Disponibles

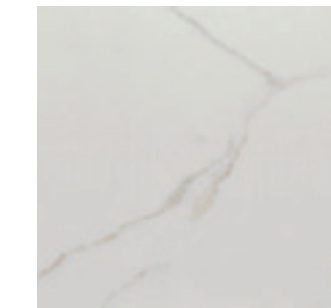

Sinclair

Combines with **Iconic** 30x30 cm_11,8"x11,8"



Iconic Red & Sinclair

TERRAE

RECTIFIED PORCELAIN TILES

Urban Style

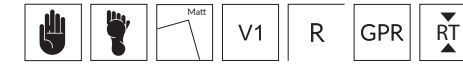

Different graphics randomly packaged

Terrae
Rectified Porcelain Tiles

30x30 cm
11,8"x11,8"



Available Sizes / Tamaños Disponibles

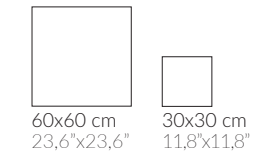

Available Colours / Colores Disponibles

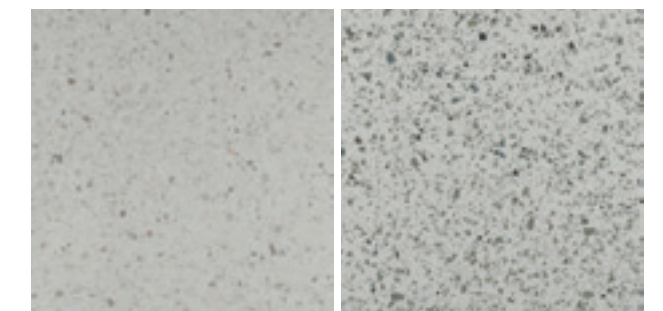

Terrae Blanco

Terrae Mix

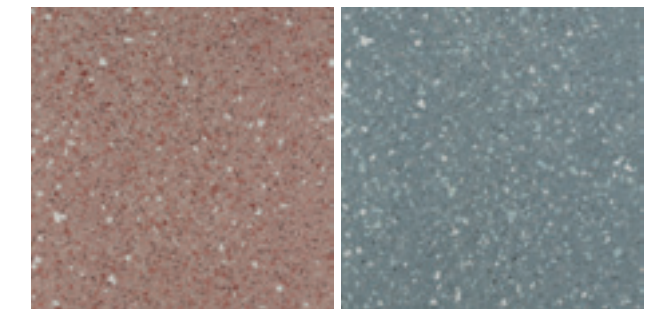

Terrae Rosa

Terrae Azul

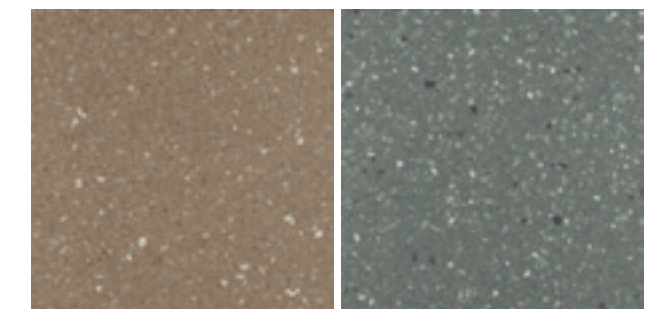

Terrae Taupe

Terrae Verde

BALBI

RECTIFIED PORCELAIN TILES

Urban Style

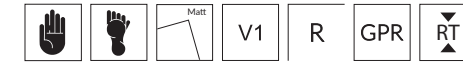

Different graphics randomly packaged

Balbi
Rectified Porcelain Tiles

60x120 cm | 60x60 cm
23,6"x47,2" | 23,6"x23,6"

23,6"x47,2" also available in 0,6"
60x120 cm también disponible en 14 mm

Available Sizes / Tamaños Disponibles

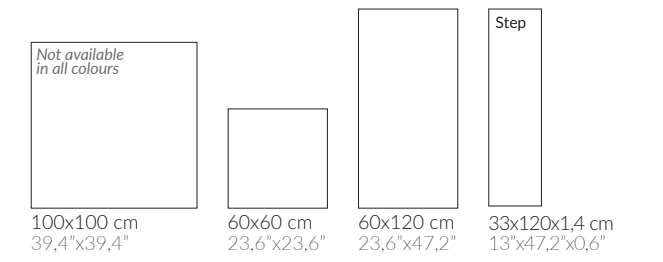

Available Colours / Colores Disponibles

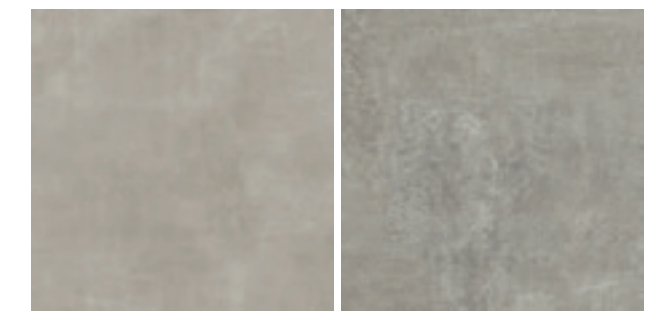

Balbi Perla

Balbi Ceniza



Balbi Gris

Balbi Marengo



Balbi Marengo & Milena White

BLESLE

RECTIFIED PORCELAIN TILES

Urban Style

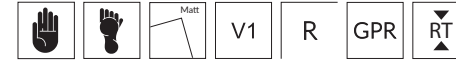

Different graphics randomly packaged

Blesle
Rectified Porcelain Tiles

60x60 cm
23,6"x23,6"

Available Sizes / Tamaños Disponibles

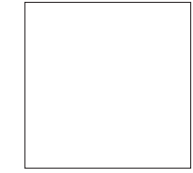

100x100 cm
39,4"x39,4"



60x60 cm
23,6"x23,6"

Available Colours / Colores Disponibles

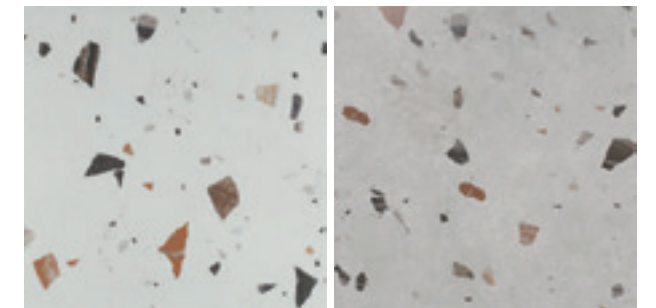

Blesle White

Blesle Pearl



Blesle Pearl

CASUAL

RECTIFIED PORCELAIN TILES

Urban Style

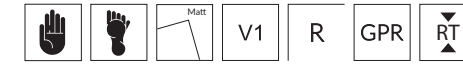

Different graphics randomly packaged

Casual
Rectified Porcelain Tiles

60x120 cm | 60x60 cm
23,6"x47,2" | 23,6"x23,6"

Available Sizes / Tamaños Disponibles

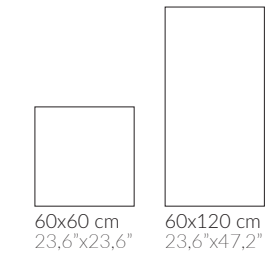

Available Colours / Colores Disponibles

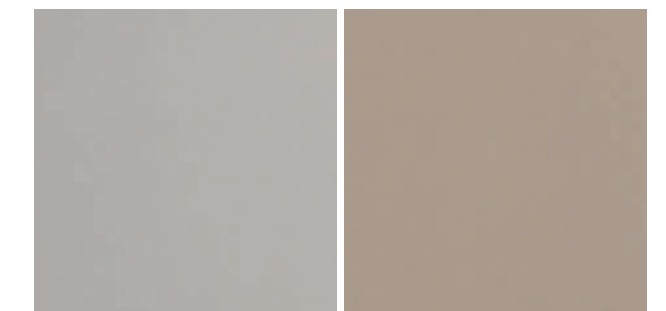

Casual Lino

Casual Avena

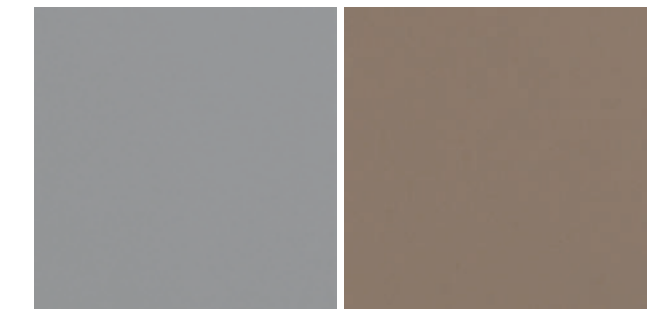

Casual Humo

Casual Avellana

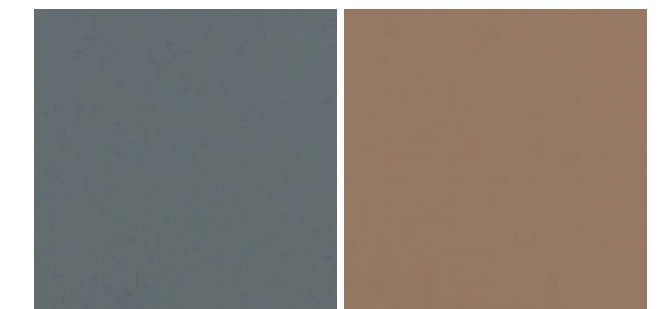

Casual Acero

Casual Cobre

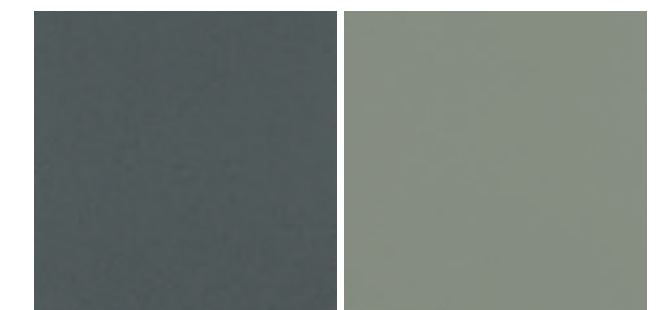

Casual Carbon

Casual Tomillo



CONCEPT

RECTIFIED PORCELAIN TILES

Urban Style

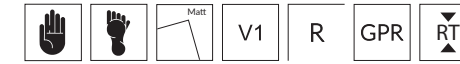

Different graphics randomly packaged

Concept
Rectified Porcelain Tiles

60x120 cm | 60x60 cm
23,6"x47,2" | 23,6"x23,6"

Available Sizes / Tamaños Disponibles

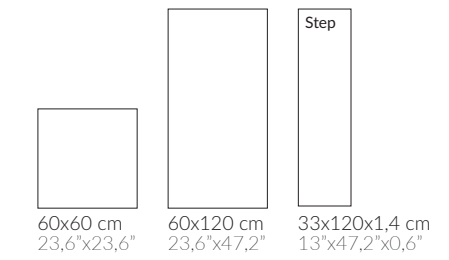

Available Colours / Colores Disponibles



Concept Grey

Concept Sand



Concept Graphite



Concept Graphite

GALDAR

RECTIFIED PORCELAIN TILES

Urban Style

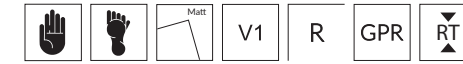

Different graphics randomly packaged

Galdar
Rectified Porcelain Tiles

60x120 cm | 60x60 cm
23,6"x47,2" | 23,6"x23,6"



Available Sizes / Tamaños Disponibles

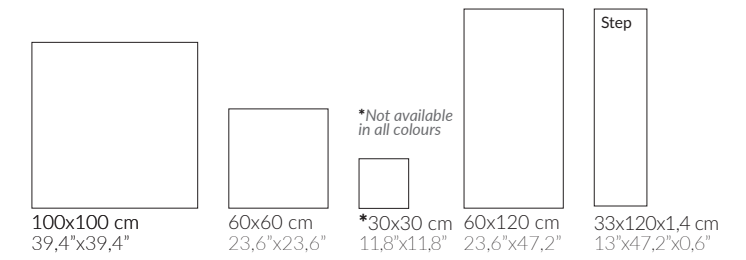

Available Colours / Colores Disponibles



Galdar Lino

Galdar Avena

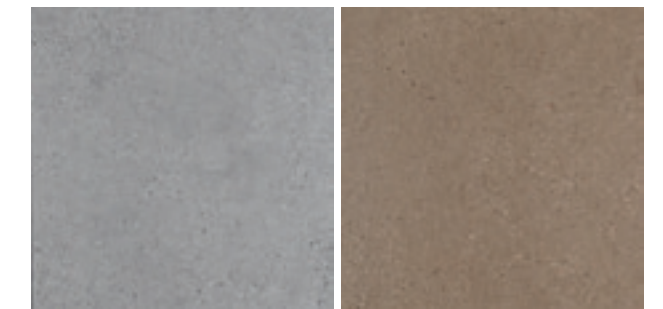

Galdar Humo

Galdar Avellana

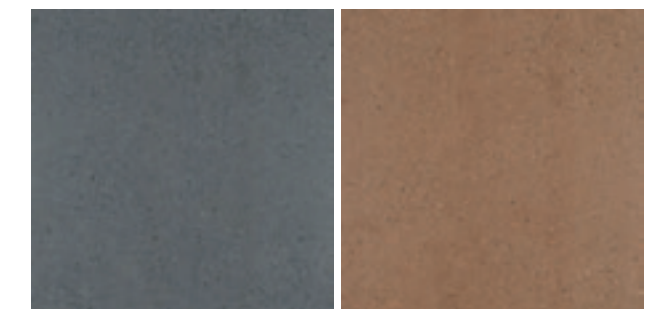

Galdar Acero

Galdar Cobre

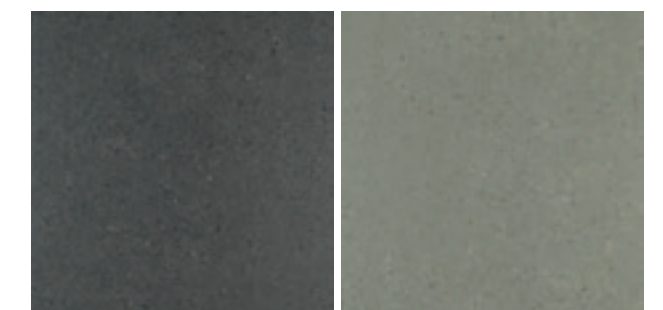

Galdar Carbon

Galdar Tomillo

● Not available in 30x30 cm

PULPIS

RECTIFIED PORCELAIN TILES

Urban Style

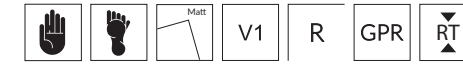

Different graphics randomly packaged

Pulpis
Rectified Porcelain Tiles

60x120 cm | 60x60 cm
23,6"x47,2" | 23,6"x23,6"

Available Sizes / Tamaños Disponibles

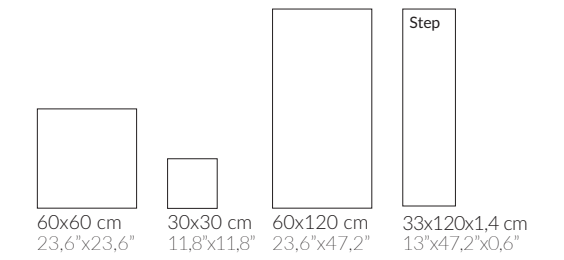

Available Colours / Colores Disponibles

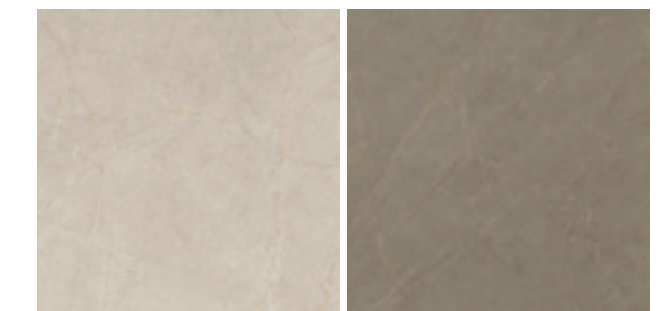

Pulpis Sand

Pulpis Taupe



Pulpis Sand

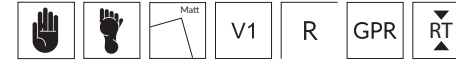

60x120 cm | 60x60 cm
23,6"x47,2" | 23,6"x23,6"

Available Sizes / Tamaños Disponibles

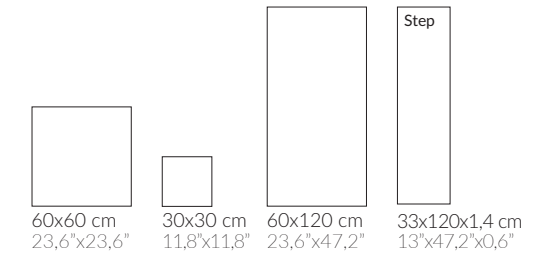

Available Colours / Colores Disponibles

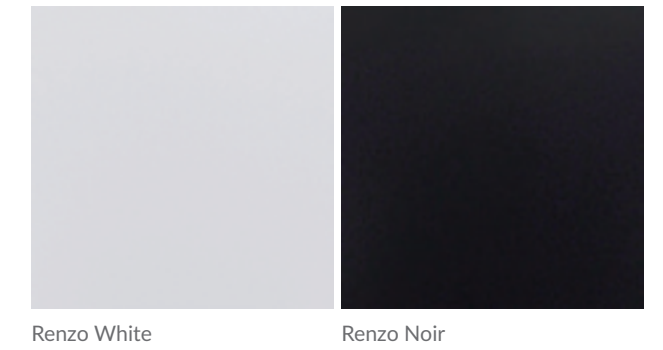

SINCLAIR

RECTIFIED PORCELAIN TILES

Urban Style

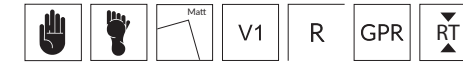

Different graphics randomly packaged

Sinclair
Rectified Porcelain Tiles

60x120 cm | 60x60 cm
23,6"x47,2" | 23,6"x23,6"

Available Sizes / Tamaños Disponibles

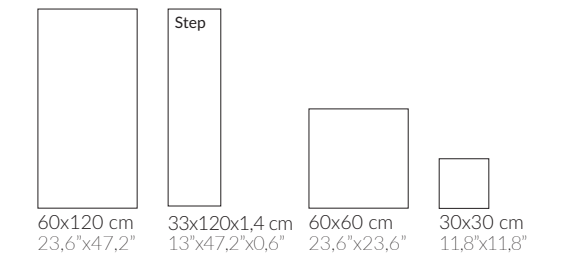

Available Colours / Colores Disponibles

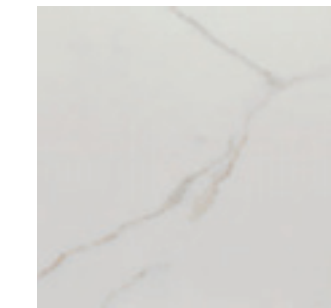

Sinclair



Sinclair

TERRAE

RECTIFIED PORCELAIN TILES

Urban Style

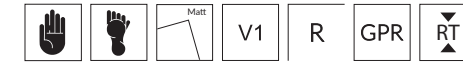

Different graphics randomly packaged

Terrae
Rectified Porcelain Tiles

60x60 cm
23,6"x23,6"

Available Sizes / Tamaños Disponibles

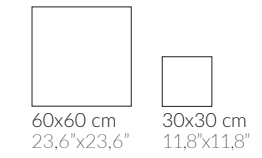

Available Colours / Colores Disponibles

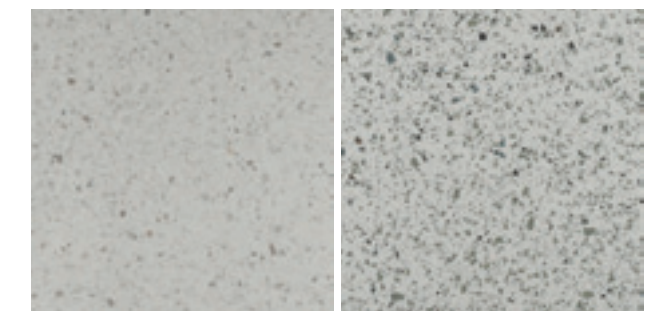

Terrae Blanco

Terrae Mix

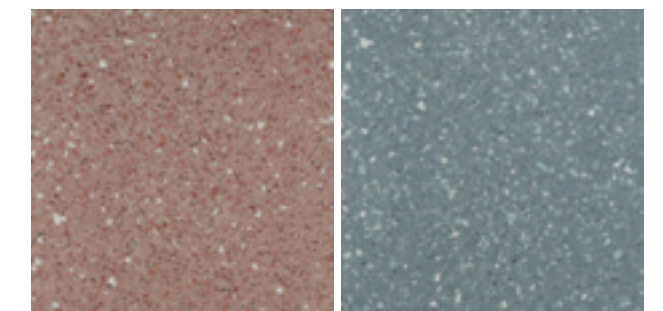

Terrae Rosa

Terrae Azul

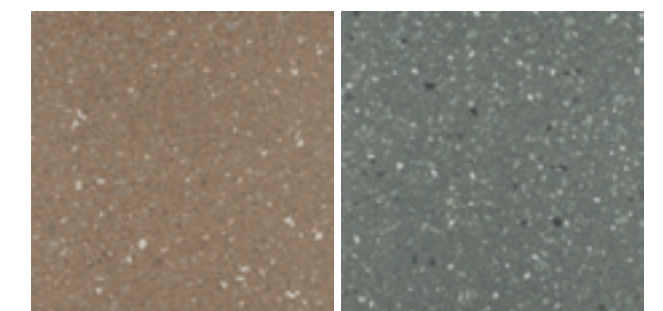

Terrae Taupe

Terrae Verde



TRAVERTINO

RECTIFIED PORCELAIN TILES

Urban Style

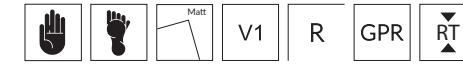

Different graphics randomly packaged

Travertino
Rectified Porcelain Tiles

60x120 cm | 60x60 cm
23,6"x47,2" | 23,6"x23,6"

Available Sizes / Tamaños Disponibles

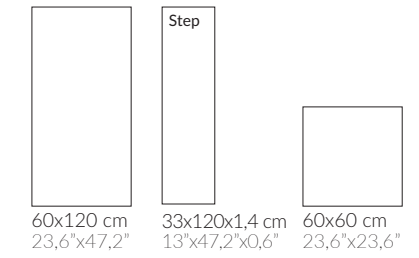

Available Colours / Colores Disponibles



Travertino Blanco

Travertino Beige



Travertino Blanco

BALBI

RECTIFIED PORCELAIN TILES

Urban Style

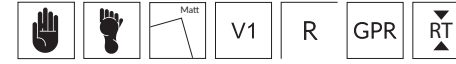

Different graphics randomly packaged

Balbi
Rectified Porcelain Tiles

100x100 cm
39,4"x39,4"



Available Sizes / Tamaños Disponibles

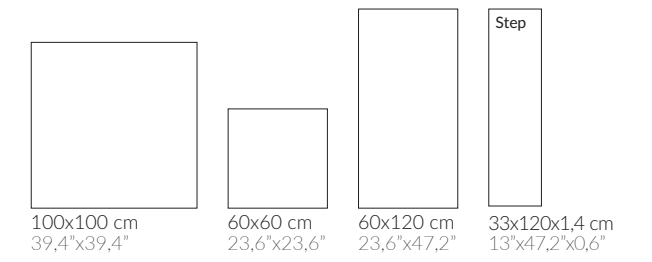

Available Colours / Colores Disponibles



Balbi Perla

Balbi Ceniza



Balbi Perla Matt

BLESLE

RECTIFIED PORCELAIN TILES

Urban Style

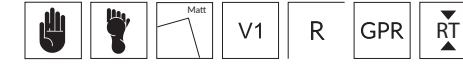

Different graphics randomly packaged

Blesle
Rectified Porcelain Tiles

100x100 cm
39,4"x39,4"



Available Sizes / Tamaños Disponibles

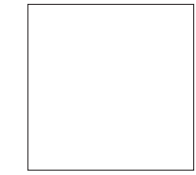

100x100 cm
39,4"x39,4"

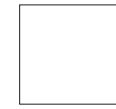

60x60 cm
23,6"x23,6"

Available Colours / Colores Disponibles

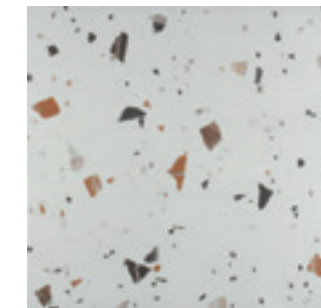

Blesle White

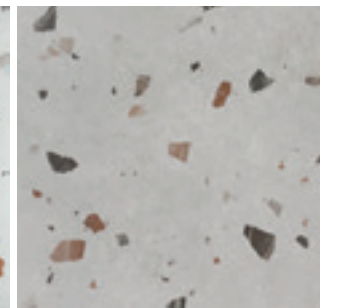

Blesle Pearl



Blesle Pearl

GALDAR

RECTIFIED PORCELAIN TILES

Urban Style

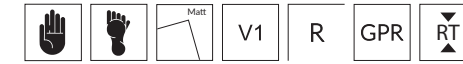

Different graphics randomly packaged

Galdar
Rectified Porcelain Tiles

100x100 cm
39,4"x39,4"



Available Sizes / Tamaños Disponibles

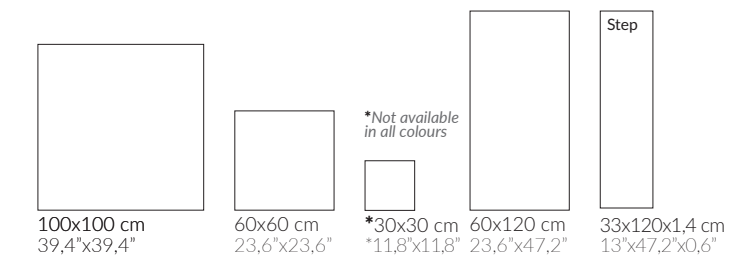

Available Colours / Colores Disponibles



Galdar Lino

Galdar Avena

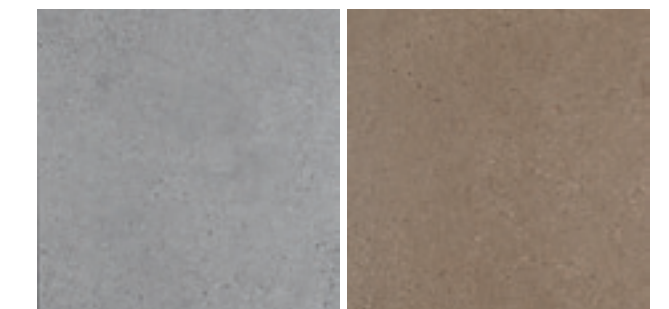

Galdar Humo

Galdar Avellana

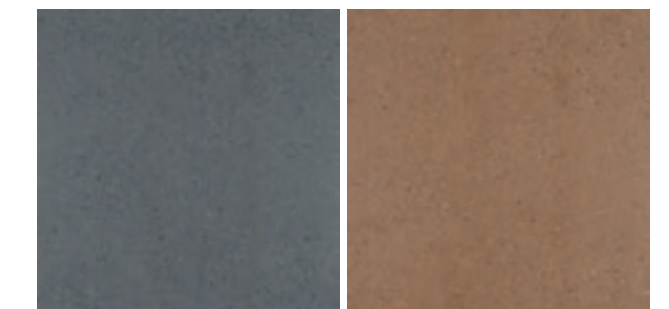

Galdar Acero

Galdar Cobre

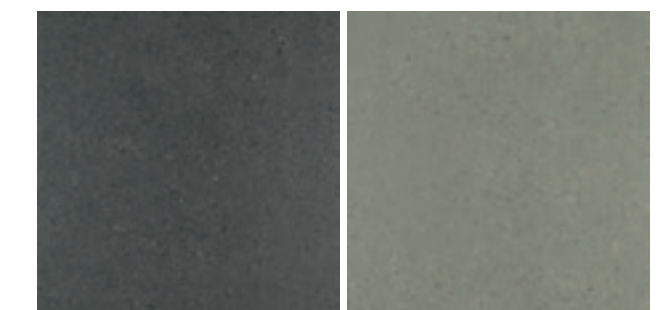

Galdar Carbon

Galdar Tomillo

• Not available in 30x30 cm

SINAI

RECTIFIED PORCELAIN TILES

Urban Style

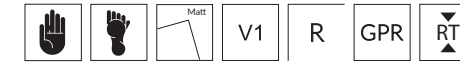

Different graphics randomly packaged

Sinai
Rectified Porcelain Tiles

100x100 cm
39,4"x39,4"

Available Sizes / Tamaños Disponibles

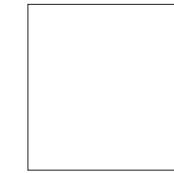

100x100 cm
39,4"x39,4"

Available Colours / Colores Disponibles



Sinai Sand

Sinai Greige



Sinai Sand & Downtown Glossy Blanco

CALIZA RLV

PORCELAIN TILES

Urban Style

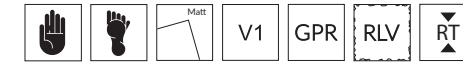

Different graphics randomly packaged

Caliza RLV
Porcelain Tiles

33,3x33,3 cm
13,1"x13,1"



Available Sizes / Tamaños Disponibles

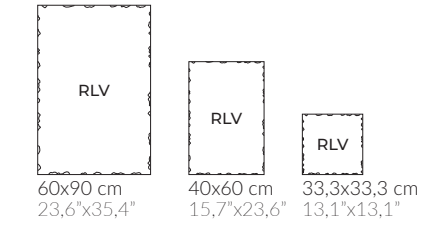

Available Colours / Colores Disponibles



Caliza RLV Sand

Caliza RLV Beige



Caliza RLV White

Combines with *Spica Caliza*, *Conques Caliza*  & *Hanko 17x52 cm*



Caliza RLV White

PALLADIO RLV

PORCELAIN TILES

Urban Style

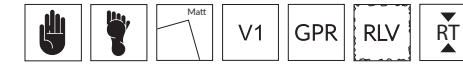

Different graphics randomly packaged

Palladio RLV
Porcelain Tiles

33,3x33,3 cm
13,1"x13,1"

Available Sizes / Tamaños Disponibles



33,3x33,3 cm
13,1"x13,1"

Available Colours / Colores Disponibles



Palladio RLV Arena

Palladio RLV Taupe

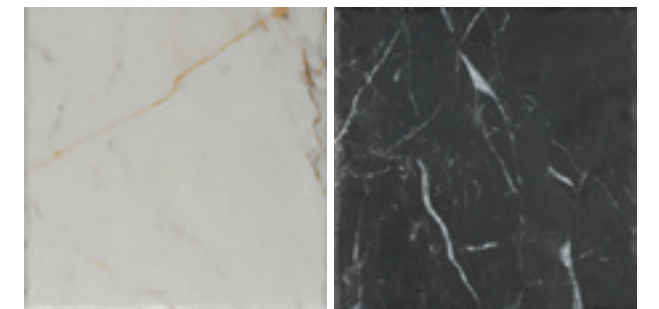

Palladio RLV Blanco

Palladio RLV Grafito



Palladio RLV Arena & RLV Taupe

TAXOS RLV

PORCELAIN TILES

Urban Style



Different graphics randomly packaged

Taxos RLV
Porcelain Tiles

33,3x33,3 cm
13,1"x13,1"



Available Sizes / Tamaños Disponibles

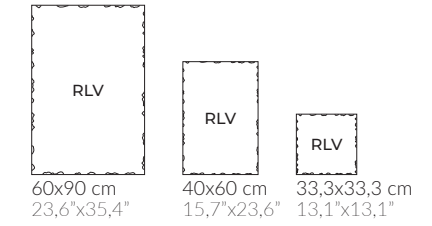

Available Colours / Colores Disponibles



Taxos RLV Sand

Taxos RLV Taupe



Taxos RLV Grey

Combines with *Spica Taxos* & *Conques Taxos*.



Taxos RLV Sand

AVALON RLV

PORCELAIN TILES

Urban Style



Different graphics randomly packaged

Avalon RLV
Porcelain Tiles

40x60 cm | 60x90 cm*
15,7"x23,6" | 23,6"x35,4"*

Available Sizes / Tamaños Disponibles

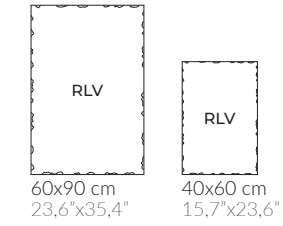

*60x90x2 cm
*23,6"x35,4"x0,8"
20 mm thickness available
in upon minimun order.
20 mm disponible bajo
pedido mínimo.

Available Colours / Colores Disponibles



Avalon RLV White



Avalon RLV Natural



Avalon RLV Natural



CALIZA RLV

PORCELAIN TILES

Urban Style

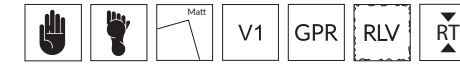

Different graphics randomly packaged

Caliza RLV
Porcelain Tiles

40x60 cm | 60x90 cm*
15,7"x23,6" | 23,6"x35,4"*

Available Sizes / Tamaños Disponibles

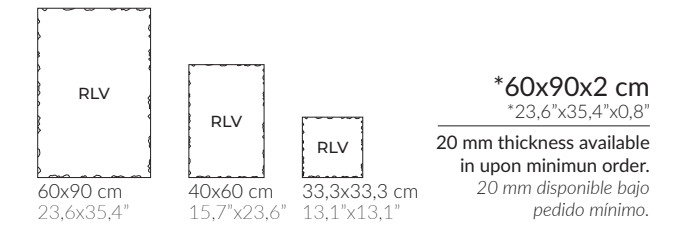

Available Colours / Colores Disponibles



Caliza RLV White



Caliza RLV Sand



Caliza RLV Beige



Combines with *Spica Caliza*, *Conques Caliza*
& *Hanko* 17x52 cm



CALIZA RLV

PORCELAIN TILES

Caliza RLV
Porcelain Tiles

60x90 cm
23,6"x35,4"
20 mm thickness available in upon minimun order.
20 mm disponible bajo pedido minimo.



Caliza RLV White



Caliza RLV Sand



Caliza RLV Beige

40x60 cm
15,7"x23,6"

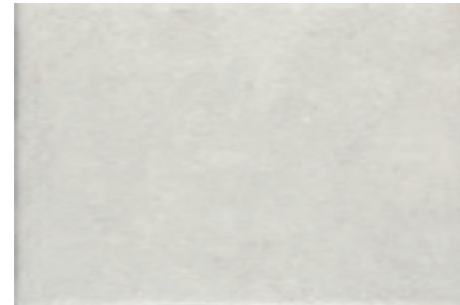

Caliza RLV White



Caliza RLV Sand



Caliza RLV Beige

33,3x33,3 cm
13,1"x13,1"

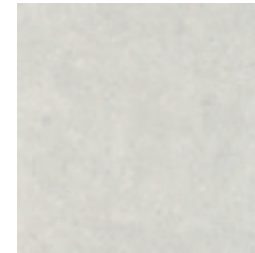

Caliza RLV White

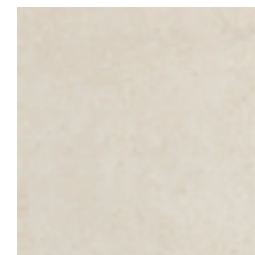

Caliza RLV Sand

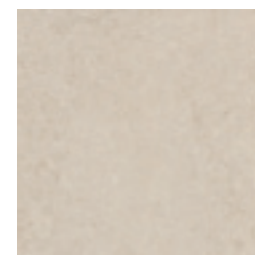

Caliza RLV Beige

Urban Style

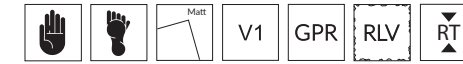

Different graphics randomly packaged

40x60x1,2 cm
15,7"x23,6"x0,5" V2



Conques Caliza Mix

40x60x1,2 cm
15,7"x23,6"x0,5" V2



Spica Caliza Mix

17x52 cm
6,7"x20,5" V2



Hanko Beige



Hanko Greige



Hanko Grafito

STRUCTURA
by BESTILE

Recommended joint width: 1.5 mm.

For optimal adhesion, prepare the grout by mixing 50% clean water and 50% latex additive.

Junta recomendada: 1,5 mm.

Para una adherencia óptima, preparar el material de rejuntado mezclando 50% de agua limpia y 50% de aditivo de látex.



Spica Caliza Mix 40x60x1,2 cm_15,7"x23,6"x0,5" & Caliza RLV Beige 60x90 cm_23,6"x35,4"

Combines with Spica Caliza, Conques Caliza & Hanko 17x52 cm



ELVAS RLV

PORCELAIN TILES

Urban Style

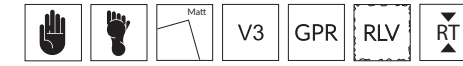

Different graphics randomly packaged

Elvas RLV
Porcelain Tiles

40x60 cm | 60x90 cm
15,7"x23,6" | 23,6"x35,4"

Available Sizes / Tamaños Disponibles

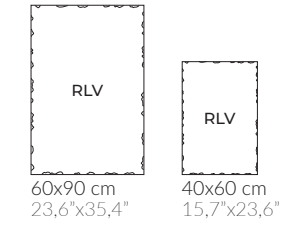

Available Colours / Colores Disponibles



Elvas RLV Gris



Elvas RLV Coto

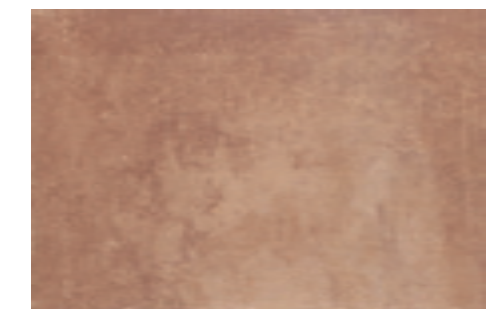

Elvas RLV Caldera



Combines with Elvas.



JULIETTE RLV

PORCELAIN TILES

Urban Style



Different graphics randomly packaged

Juliette RLV
Porcelain Tiles

40x60 cm | 60x90 cm*
15,7"x23,6" | 23,6"x35,4"*

Available Sizes / Tamaños Disponibles

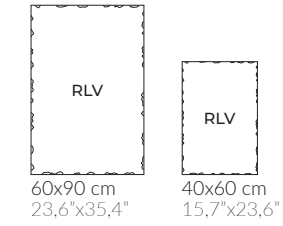

*60x90x2 cm
*23,6"x35,4"x0,8"
20 mm thickness available
in upon minimun order.
20 mm disponible bajo
pedido mínimo.

Available Colours / Colores Disponibles



Juliette RLV Nude



Juliette RLV Natural

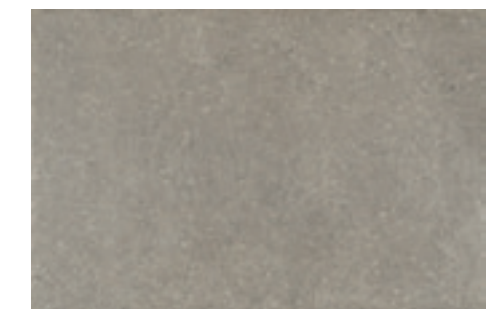

Juliette RLV Piedra



KORAL RLV

PORCELAIN TILES

Urban Style

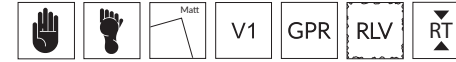

Different graphics randomly packaged

Koral RLV
Porcelain Tiles

40x60 cm | 60x90 cm*
15,7"x23,6" | 23,6"x35,4"*

Available Sizes / Tamaños Disponibles

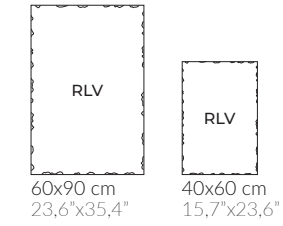

*60x90x2 cm
*23,6"x35,4"x0,8"

20 mm thickness available
in upon minimun order.
20 mm disponible bajo
pedido mínimo.

Available Colours / Colores Disponibles

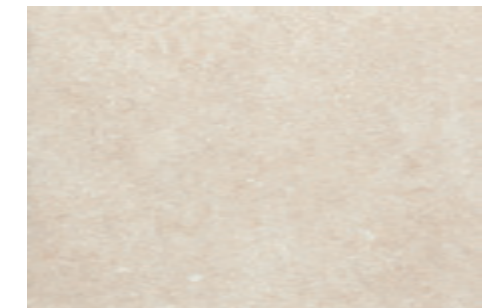

Koral RLV Beige



Koral RLV Beige

NAOS RLV

PORCELAIN TILES

Urban Style

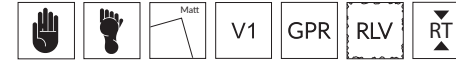

Different graphics randomly packaged

Naos RLV
Porcelain Tiles

40x60 cm | 60x90 cm
15,7"x23,6" | 23,6"x35,4"

Available Sizes / Tamaños Disponibles

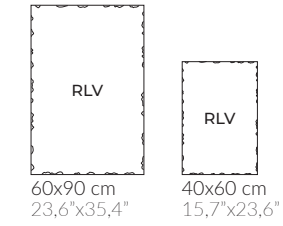

Available Colours / Colores Disponibles



Naos RLV Beige



Naos RLV Gris

Combines with Naos, Nelson & Newry. 



Naos RLV Gris

PRESTON RLV

PORCELAIN TILES

Urban Style

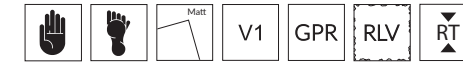

Different graphics randomly packaged

Preston RLV
Porcelain Tiles

40x60 cm | 60x90 cm
15,7"x23,6" | 23,6"x35,4"

Available Sizes / Tamaños Disponibles

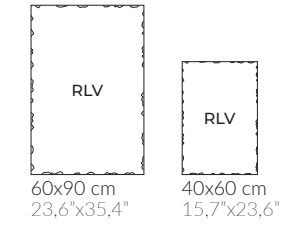

Available Colours / Colores Disponibles

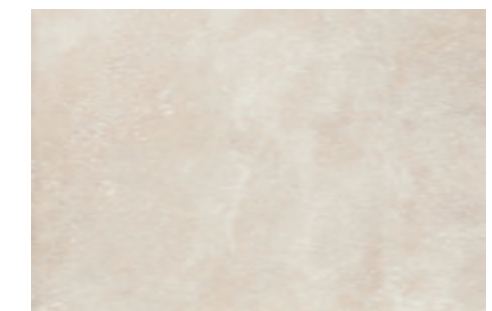

Preston RLV Sand

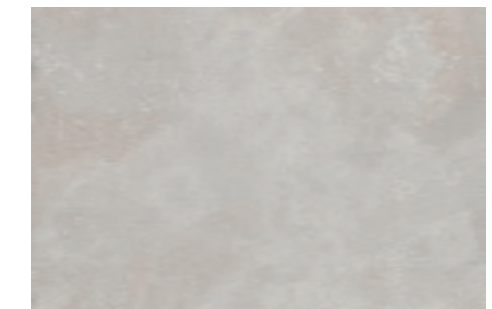

Preston RLV Piedra



Preston RLV Sand

SINAI RLV

PORCELAIN TILES

Urban Style

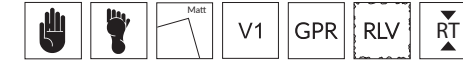

Different graphics randomly packaged

Sinai RLV
Porcelain Tiles

40x60 cm | 60x90 cm
15,7"x23,6" | 23,6"x35,4"

Available Sizes / Tamaños Disponibles

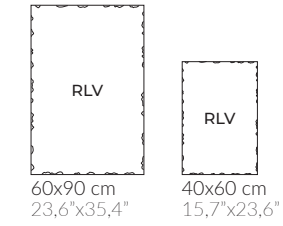

Available Colours / Colores Disponibles

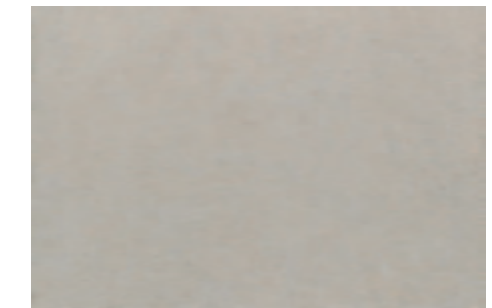

Sinai RLV Sand



Sinai RLV Taupe

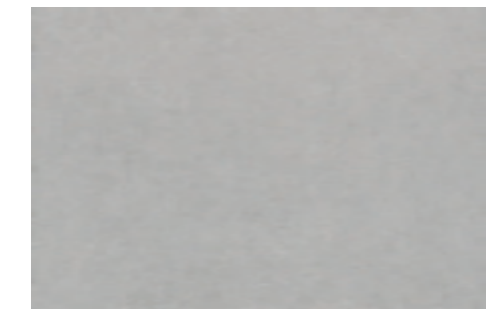

Sinai RLV Pearl

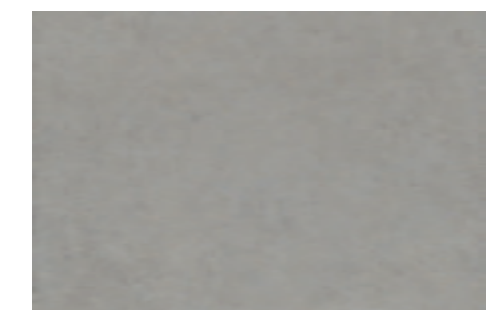

Sinai RLV Grey



TAXOS RLV

PORCELAIN TILES

Urban Style



Different graphics randomly packaged

Taxos RLV
Porcelain Tiles

40x60 cm | 60x90 cm*
15,7"x23,6" | 23,6"x35,4"*

Available Sizes / Tamaños Disponibles

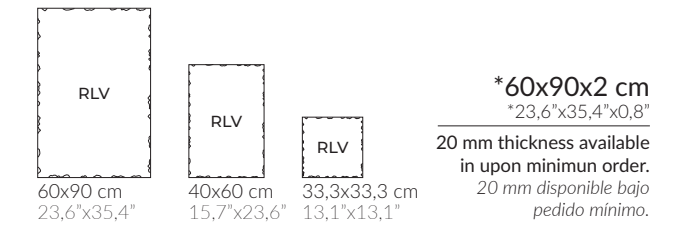

Available Colours / Colores Disponibles



Taxos RLV Sand

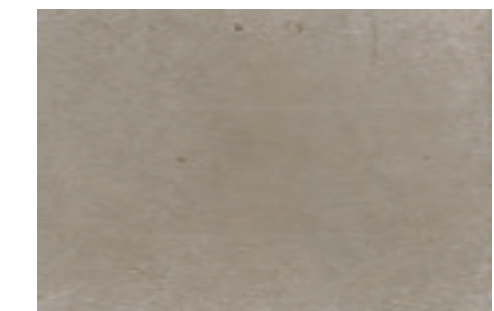

Taxos RLV Taupe

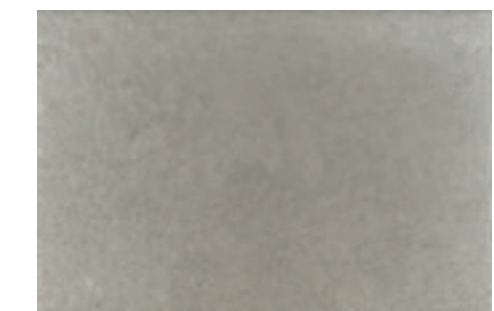

Taxos RLV Grey



Combines with *Spica Taxos*
& *Conques Taxos*.



TAXOS RLV

PORCELAIN TILES

Taxos RLV
Porcelain Tiles

Urban Style



Different graphics randomly packaged

33,3x33,3 cm | 40x60 cm | 60x90 cm
13,1"x13,1" | 15,7"x23,6" | 23,6"x35,4"

60x90 cm
23,6"x35,4"
20 mm thickness available in upon minimun order.
20 mm disponible bajo pedido minimo.



Taxos RLV Sand

40x60 cm
15,7"x23,6"



Taxos RLV Sand

33,3x33,3 cm
13,1"x13,1"

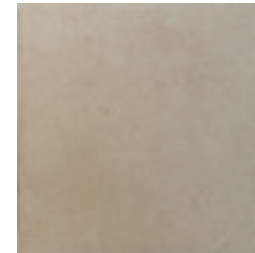

Taxos RLV Sand

40x60x1,2 cm
15,7"x23,6"x0,5"



Conques Taxos Sand

40x60x1,2 cm
15,7"x23,6"x0,5"



Spica Taxos Sand



Spica Taxos Sand & Taxos RLV Sand



Taxos RLV Taupe

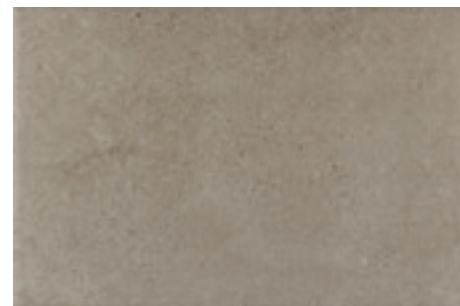

Taxos RLV Taupe

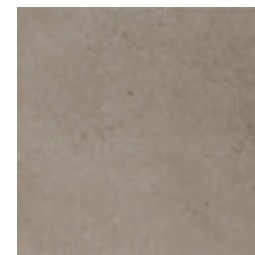

Taxos RLV Taupe



Conques Taxos Taupe



Spica Taxos Taupe



Conques Taxos Grey

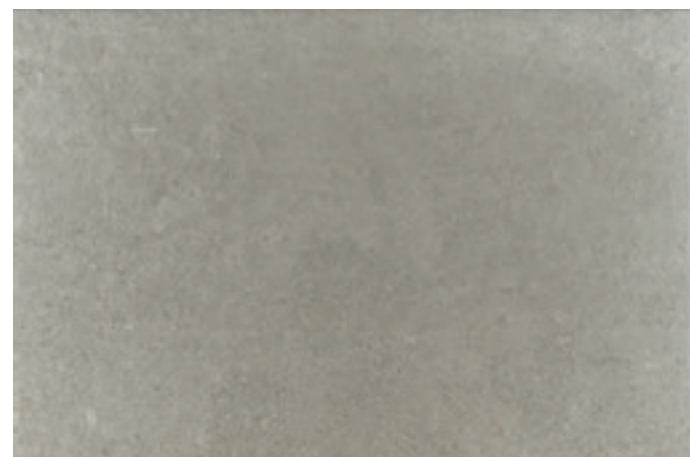

Taxos RLV Grey



Taxos RLV Grey

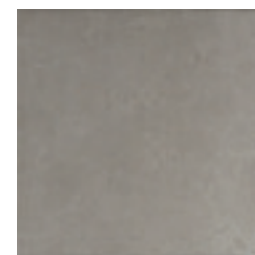

Taxos RLV Grey



Conques Taxos Grey



Spica Taxos Grey



Recommended joint width: 1.5 mm.

For optimal adhesion, prepare the grout by mixing 50% clean water and 50% latex additive.

Junta recomendada: 1,5 mm.

Para una adherencia óptima, preparar el material de rejuntado mezclando 50% de agua limpia y 50% de aditivo de látex.

Combines with Spica Taxos & Conques Taxos.

TINEO RLV

PORCELAIN TILES

Urban Style

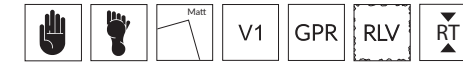

Different graphics randomly packaged

Tineo RLV
Porcelain Tiles

40x60 cm | 60x90 cm
15,7"x23,6" | 23,6"x35,4"



Available Sizes / Tamaños Disponibles

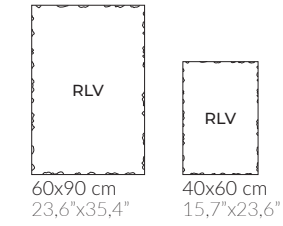

Available Colours / Colores Disponibles



Tineo RLV Arena



Tineo RLV Piedra

Combines with **Tineo.**



Tineo RLV Arena

BESTILE
Time to Create

STONE
Porcelain Tiles



ALABAMA

PORCELAIN TILES

Stone

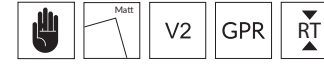

Different graphics randomly packaged

Alabama
Porcelain Tiles

17x52 cm
6,7"x20,5"



Alabama White



Alabama Nature



Alabama Graphite



Alabama

BADEN

PORCELAIN TILES

Stone

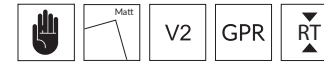

Different graphics randomly packaged

Baden
Porcelain Tiles

17x52 cm
6,7"x20,5"



Baden Perla



Baden Ceniza



Baden Marengo

Combines with **Balbi**.



Baden Ceniza

BERGAMOT

PORCELAIN TILES

Stone

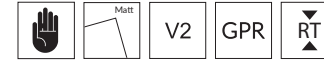

Different graphics randomly packaged

Bergamot
Porcelain Tiles
17x52 cm
6,7"x20,5"



Bergamot Sand



Bergamot Grey



Bergamot Noir

Combines with Pierre.



Bergamot

CONCEPT

PORCELAIN TILES

Stone



Different graphics randomly packaged

Concept
Porcelain Tiles
17x52 cm
6,7"x20,5"



Concept Sand



Concept Grey



Concept Graphite

Combines with Concept.



Concept Grey & Concept Sand

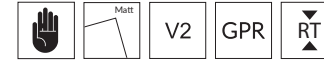

Different graphics randomly packaged



Galdar Avena



Galdar Avellana



Galdar Acero



Galdar Tomillo

Combines with **Galdar**.



Galdar



Different graphics randomly packaged

17x52 cm
6,7"x20,5"



Hanko Beige



Hanko Greige



Hanko Grafito

Combines with *Caliza RLV*.



Hanko

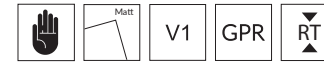

Milena White



Milena Grey



Milena Noir



Milena



BESTILE
Time to Create

WOODS
Rectified Porcelain Tiles

THASOS

RECTIFIED PORCELAIN TILES

Woods

Thasos
Rectified Porcelain Tiles

25x150 cm
9,8"x59"

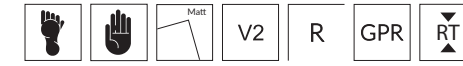

Different graphics randomly packaged

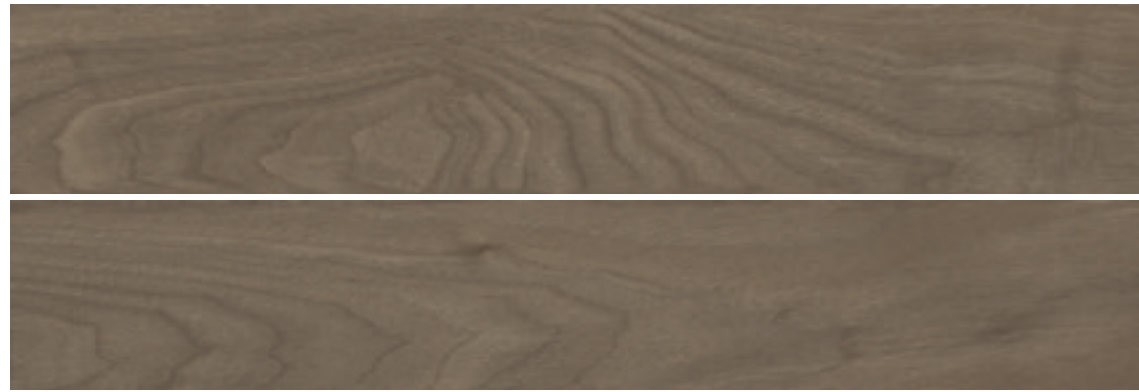

Thasos Natural

2 tiles shown

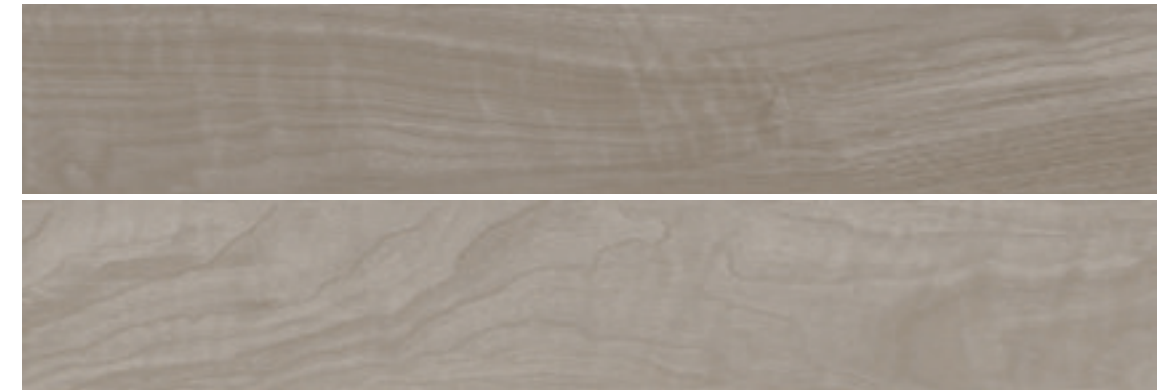

Thasos Greige

2 tiles shown



ELEGANCE

RECTIFIED PORCELAIN TILES

Woods

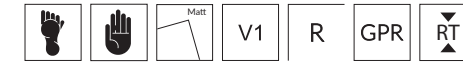

Different graphics randomly packaged

Elegance
Rectified Porcelain Tiles

20x120 cm
7,8"x47,2"



Elegance Nature



Elegance Roble



Elegance Roble 20x120 cm_7,8"x47,2"

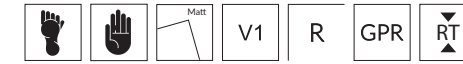

Different graphics randomly packaged

MULTI 1* | 20x120 cm
*Only on request | 7,8"x47,2"
Solo bajo pedido



Isar Arce



Isar Haya



Isar Nuez

***MULTI 1**
 Box composition:
 30x120 cm_1pc / 20x120 cm_1pc / 15x120 cm_2 pc / 10x120 cm_1 pc

30x120 cm_11,8"x47,2"	R
20x120 cm_7,8"x47,2"	R
15x120 cm_5,9"x47,2"	R
10x120 cm_3,9"x47,2"	R



Isar Nuez Multi 1

MONEO

RECTIFIED PORCELAIN TILES

Woods

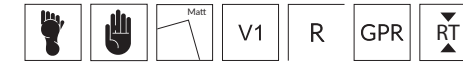

Different graphics randomly packaged

Moneo
Rectified Porcelain Tiles

20x120 cm
7,8"x47,2"



Moneo Blanco



Moneo Taupe



Moneo Nature



Moneo Blanco 20x120 cm_7,8"x47,2"

TIPUANA

RECTIFIED PORCELAIN TILES

Woods

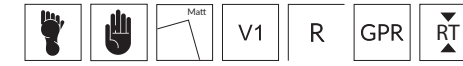

Different graphics randomly packaged

Tipuana
Rectified Porcelain Tiles

20x120 cm
7,8"x47,2"



Tipuana Nogal



Tipuana Acacia



Tipuana Acacia 20x120 cm_7,8"x47,2" & Mailo Beige 5x25 cm_2"x9,8"

BESTILE
Time to Create

**FOURTEEN &
TWENTY**
*14 & 20 mm Thickness
Porcelain Cobbles*

ALSACIA

PORCELAIN COBBLES

14 & 20 mm Thickness



Different graphics randomly packaged

Alsacia
Porcelain Cobbles

20x20x2 cm | 20x30x2 cm
7,8"x7,8"x0,8" | 7,8"x11,8"x0,8"
20x20x1,4 cm | 20x30x1,4 cm
7,8"x7,8"x0,6" | 7,8"x11,8"x0,6"



Alsacia Nature



Alsacia Cotto

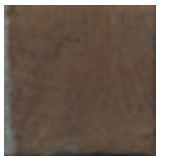

Alsacia Antique



Alsacia Nature



Alsacia Cotto



Alsacia Antique



Alsacia Cotto

ARAN

PORCELAIN COBBLES

14 & 20 mm Thickness

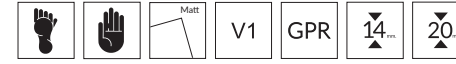

Different graphics randomly packaged

Aran
Porcelain Cobbles

20x20x2 cm | 20x30x2 cm
7,8"x7,8"x0,8" | 7,8"x11,8"x0,8"
20x20x1,4 cm | 20x30x1,4 cm
7,8"x7,8"x0,6" | 7,8"x11,8"x0,6"



Aran Nat Pearl & Tex Pearl

PIERRE

PORCELAIN COBBLES

14 & 20 mm Thickness



Different graphics randomly packaged

Pierre
Porcelain Cobbles

20x20x2 cm | 20x30x2 cm
7,8"x7,8"x0,8" | 7,8"x11,8"x0,8"
20x20x1,4 cm | 20x30x1,4 cm
7,8"x7,8"x0,6" | 7,8"x11,8"x0,6"

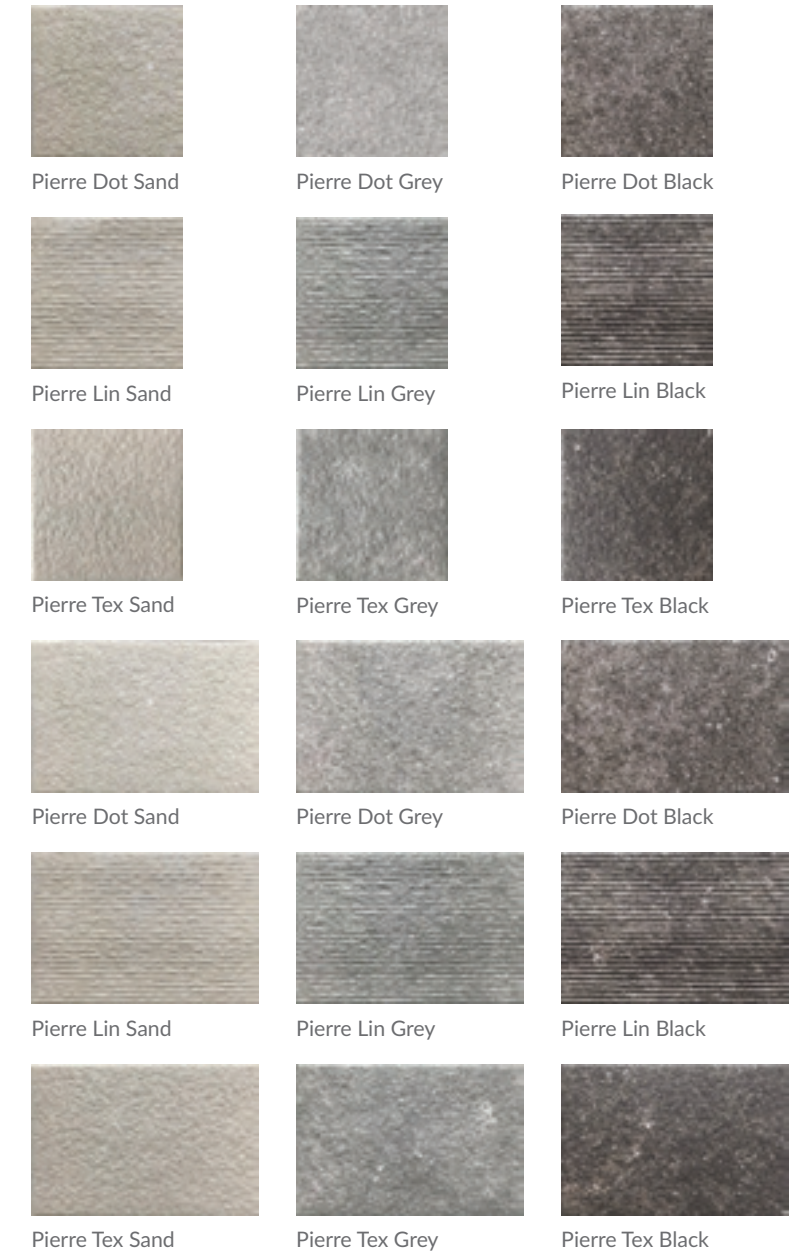

PORFIDO TEX

PORCELAIN COBBLES

14 & 20 mm Thickness

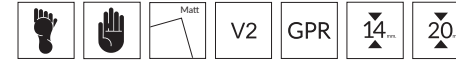

Different graphics randomly packaged

Porfido Tex
Porcelain Cobbles

20x20x2 cm | 20x30x2 cm
7,8"x7,8"x0,8" | 7,8"x11,8"x0,8"
20x20x1,4 cm | 20x30x1,4 cm
7,8"x7,8"x0,6" | 7,8"x11,8"x0,6"



Porfido Tex Beige



Porfido Tex Brown

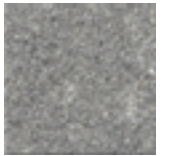

Porfido Tex Grey



Porfido Tex Beige

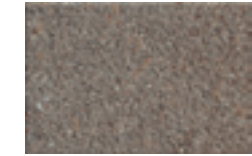

Porfido Tex Brown



Porfido Tex Grey



Porfido Tex Grey

PIERRE DOT

RECTIFIED PORCELAIN TILES

14 Thickness

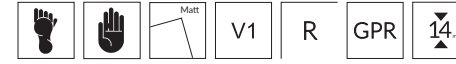

Different graphics randomly packaged

Pierre Dot
Rectified Porcelain Tiles

60x120x1,4 cm | 60x60x1,4 cm
23,6"x47,2"x0,6" | 23,6"x23,6"x0,6"

Available Sizes / Tamaños Disponibles

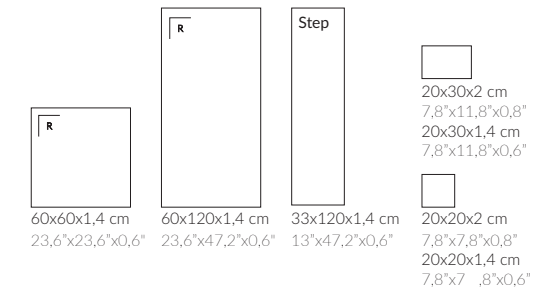

Available Colours / Colores Disponibles



Pierre Dot Grey

Pierre Dot Sand



Pierre Dot Black



Pierre Dot Black & Burns Noir



BESTILE
Time to Create

**TECHNICAL
INFORMATION**
Información Técnica

How to read this catalogue

Como leer este catálogo

1 Environment proposal
Propuesta de ambiente

2 Serie name
Nombre de la serie

3 Description of the environment
Descripción del ambiente

4 Product detail photo
Foto detalle producto

5 Available formats
Formatos disponibles

6 Product typology
Tipología de producto

- RECTIFIED POLISHED PORCELAIN TILES
- Azulejo Porcelánico Pulido y Rectificado
- RECTIFIED PORCELAIN TILES
- Azulejo Porcelánico Rectificado
- PORCELAIN TILES
- Azulejo Porcelánico
- 14 & 20 MM THICKNESS PORCELAIN TILES
- Azulejo Porcelánico Espesorado de 14 y 20 mm
- WHITE BODY TILES
- Pasta Blanca

7 Available colors
Colores disponibles

8 Tile image
Imagen de una pieza

9 Icons of ceramic finish
Iconos del acabado cerámico

10 Category
Categoría

BESTILE
Time to Create

10 Urban Style
9
6 Galdar Rectified Porcelain Tiles
100x100 cm | 60x120 cm | 60x60 cm
39,4"x39,4" | 23,6"x47,2" | 23,6"x23,6"

10 5
5 5
7 8

Available Sizes / Tamaños Disponibles

Available Colours / Colores Disponibles

Galdar Lino Galdar Avena
Galdar Humo Galdar Avellana
Galdar Acero Galdar Cobre
Galdar Carbon Galdar Tomillo

BESTILE | 189

2 **GALDAR**
6 RECTIFIED PORCELAIN TILES



2 **BADEN**
6 PORCELAIN TILES



Special Pieces 14 & 20 mm

Piezas especiales 14 & 20 mm

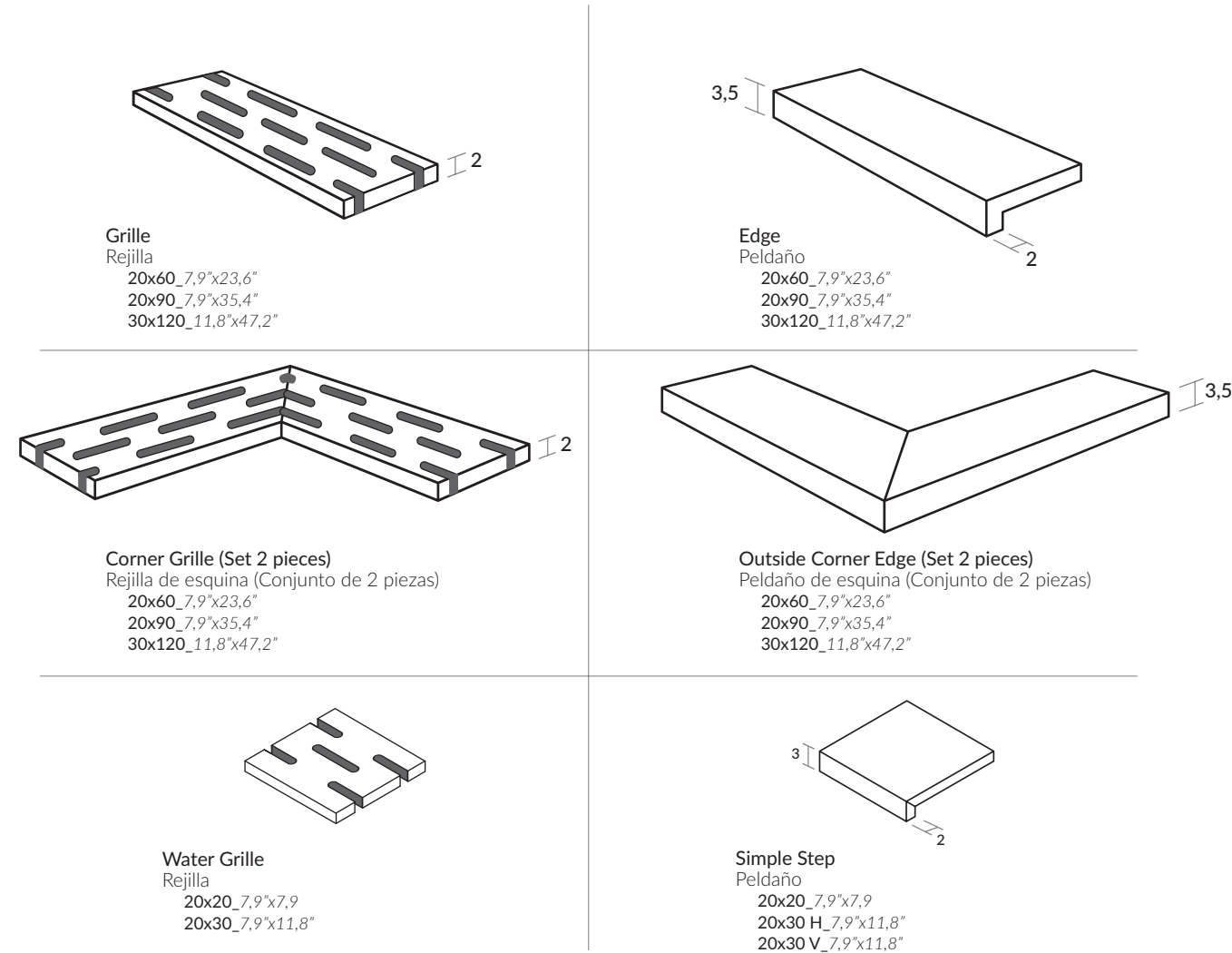

Zones Áreas

	AIRPORTS AEROPUERTOS AEROPORTS FLUGHÄFEN		RESTAURANTS RESTAURANTES RESTAURANTS RESTAURANT		PARKS PARQUES PARCS PARKS
	DRIVE WAYS ENTRADA DE COCHES SOLS CARROSSABLES PKW-EINFAHRT		SHOPPING AREAS ZONA COMERCIAL ZONES COMMERCIALES EINKAUFSZENTREN		HOTELS HOTELES HÔTELS HOTELS
	OUTDOOR STAIRS PERRONS ESCALERAS EXTERIORES ESCALIERS EXTERIEURS AUGENTREPPEN		INDUSTRIAL AREAS AREAS INDUSTRIALES ZONES INDUSTRIELLES INDUSTRIEBEREICHE		SHOWERS DUCHAS DOUCHES DUSCHEN
	GARDENS, PATHS... JARDINES, CAMINOS... JARDINS, CHEMINEMENTS... GÄRTEN, WEGE...		TERRACES TERRAZAS TERRASSES TERRASSEN		SWIMMING POOL SURROUNDS ALREDEDORES DE LA PISCINA BORDURES DE PISCINE UMGEBUNG VON SCHWIMBÄDERN
	URBAN LOCATIONS UBICACIONES URBANAS ZONES URBAINES URBANE BEREICHE		HEAVY TRAFFIC AREAS ZONAS DE ALTO TRANSITO ZONES A FORT PASSAGE VIEL BEGANGENE BEREICHE		OUTDOOR EXTERIOR EXTERIEUR AUBENBEREICH

Icons meaning

Significado de los iconos

	Wall Tiles Revestimiento
	Floor Tiles Pavimento
	Matt Finish Acabado Mate
	Glossy Finish Acabado Brillo
	Matt_Glossy Finish Acabado Mate_Brillo
V1	Light Shade Variation Apariencia uniforme
V2	Medium Shade Variation Ligera variación
V3	High Shade Variation Moderada variación
V4	Super High Shade Variation Sustancial variación
R	Rectified Tiles Piezas Rectificadas
PB	White Body Tiles Pasta Blanca
GPR	Porcelain Tiles Porcelánico esmaltado
	Regular Thickness Espesor normal
	12 mm Thickness Espesor 12 mm
	14 mm Thickness Espesor 14 mm
	20 mm Thickness Espesor 20 mm
RLV	RLV - Special RELIEF RLV - Relieve especial



Types of laying

Tipos de colocación

Below are some examples of placement, depending on the format of the tiles.
Aquí se muestran algunos ejemplos de colocación, según el formato de las baldosas.

DECORATIVE TILES, RECTANGULAR FORMAT 2"x9,8" / 2,6"x7,9" / 2,9"x11,8" / 3,9"x11,8"
FORMATO RECTANGULAR, PIEZAS DECORATIVE 5x25 cm / 6,5x20 cm / 7,5x30 cm / 10x30 cm

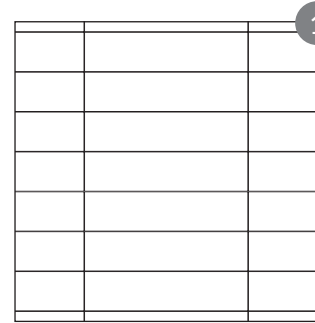

1
Traditional rectangular format laying in horizontal.
Colocación tradicional formato rectangular en horizontal.

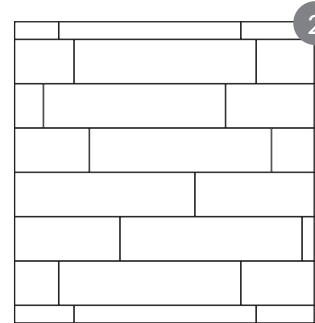

2
Looked laying.
Colocación trabada.

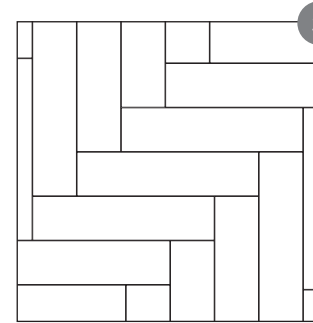

3
90° herringbone laying.
Colocación en espiga 90°

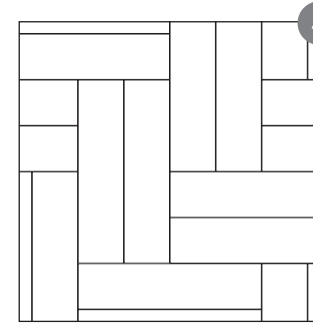

4
90° herringbone laying two tiles.
Colocación en espiga dos piezas 90°

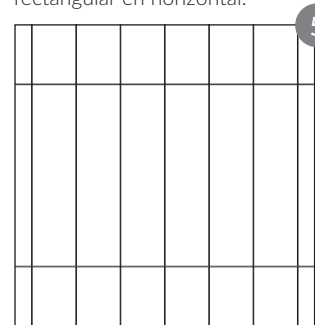

5
Traditional rectangular format laying in vertical.
Colocación tradicional formato rectangular en vertical.

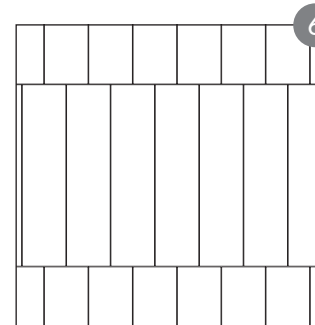

6
Vertical placement moved 50%
Colocación en vertical movida 50%

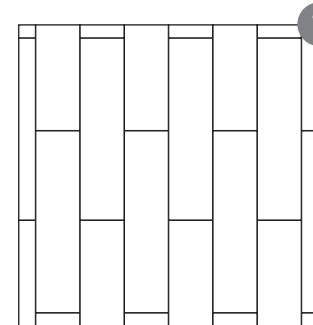

7
Vertical placement moved 50%
Colocación en vertical movida 50%

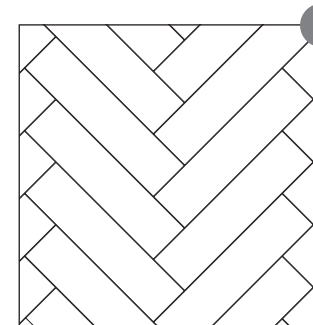

8
45° herringbone laying
Colocación en espiga 45°

TILES RECTANGULAR FORMAT 23,6"x47,2"
FORMATO RECTANGULAR PIEZAS 60x120 cm

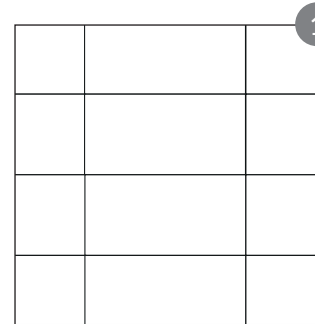

1
Traditional rectangular format laying in horizontal.
Colocación tradicional formato rectangular en horizontal.

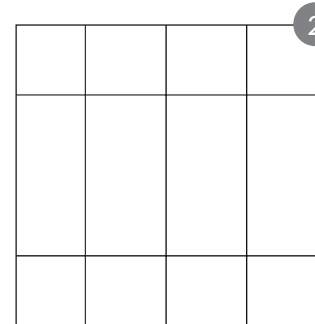

2
Traditional rectangular format laying in vertical.
Colocación tradicional formato rectangular en vertical.

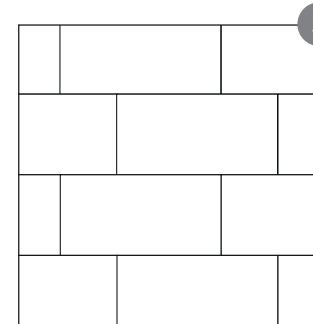

3
Rectangular format laying with running joint.
Colocación formato rectangular con junta corrida.

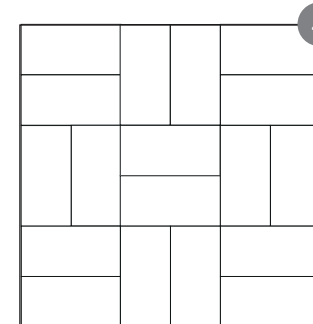

4
Two by two laying in rectangular format.
Colocación dos a dos en formato rectangular.

FORMAT SCHEMES 7,8"x7,8" & 7,8"x11,8"
ESQUEMAS FORMATO 20x20 cm y 20x30 cm

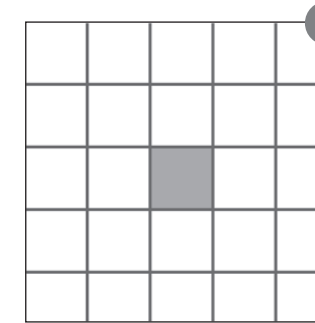

1
1m² | 20x30cm_7,8"x11,8" - 0% m²
20x20cm_7,8"x7,8" - 100% m²

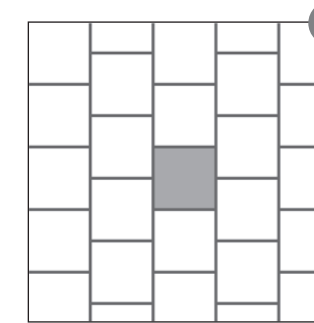

2
1m² | 20x30cm_7,8"x11,8" - 0% m²
20x20cm_7,8"x7,8" - 100% m²



3
1m² | 20x30cm_7,8"x11,8" - 72,7% m²
20x20cm_7,8"x7,8" - 27,3% m²

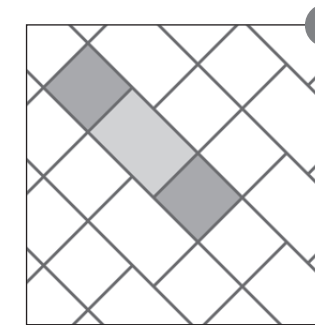

4
1m² | 20x30cm_7,8"x11,8" - 44,7% m²
20x20cm_7,8"x7,8" - 55,3% m²

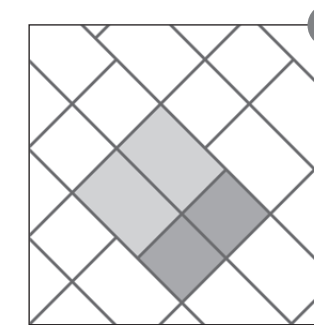

5
1m² | 20x30cm_7,8"x11,8" - 63,8% m²
20x20cm_7,8"x7,8" - 36,2% m²

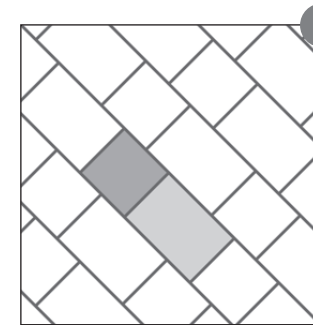

6
1m² | 20x30cm_7,8"x11,8" - 62,8% m²
20x20cm_7,8"x7,8" - 37,2% m²

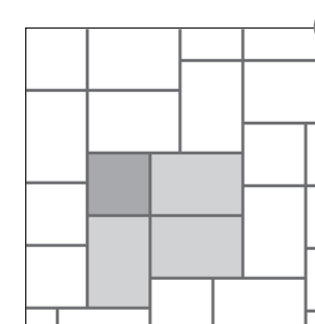

7
1m² | 20x30cm_7,8"x11,8" - 77,8% m²
20x20cm_7,8"x7,8" - 22,2% m²

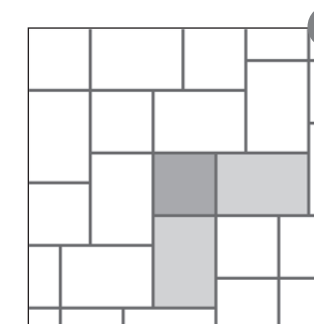

8
1m² | 20x30cm_7,8"x11,8" - 72,7% m²
20x20cm_7,8"x7,8" - 27,3% m²

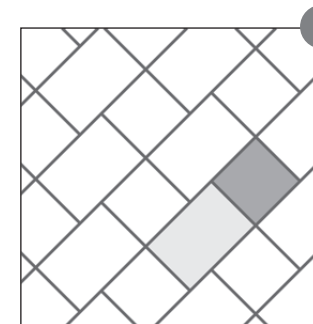

9
1m² | 20x30cm_7,8"x11,8" - 64,7% m²
20x20cm_7,8"x7,8" - 35,3% m²

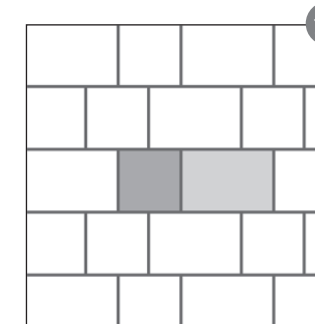

10
1m² | 20x30cm_7,8"x11,8" - 64,7% m²
20x20cm_7,8"x7,8" - 35,3% m²

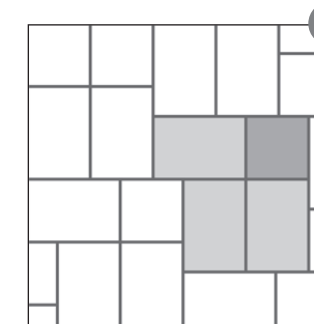

11
1m² | 20x30cm_7,8"x11,8" - 64,7% m²
20x20cm_7,8"x7,8" - 35,3% m²

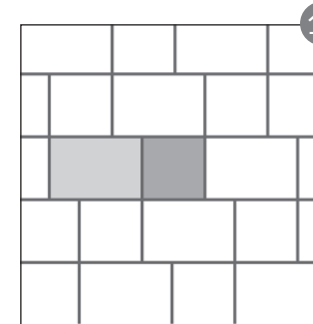

12
1m² | 20x30cm_7,8"x11,8" - 61,9% m²
20x20cm_7,8"x7,8" - 38,1% m²

Types of laying

Tipos de colocación

Below are some examples of placement, depending on the format of the tiles.
Aquí se muestran algunos ejemplos de colocación, según el formato de las baldosas.

FORMAT SCHEMES 7,8"x7,8" & 7,8"x11,8"

ESQUEMAS FORMATO 20x20 cm y 20x30 cm

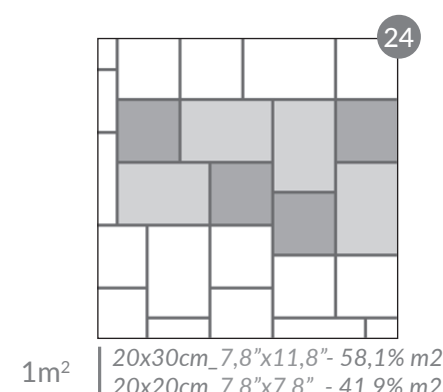
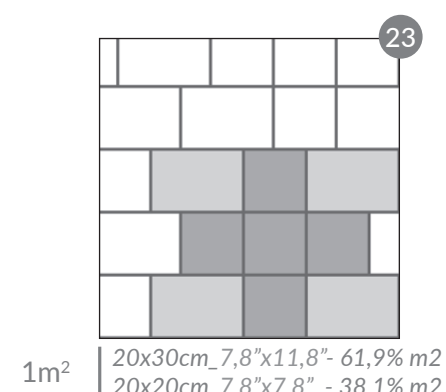
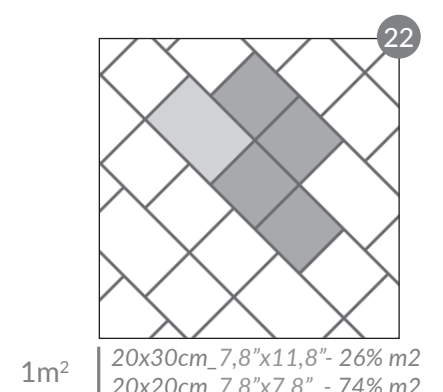
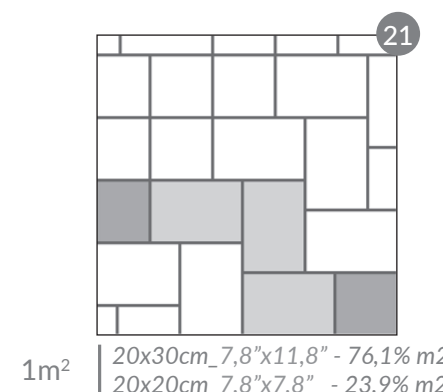
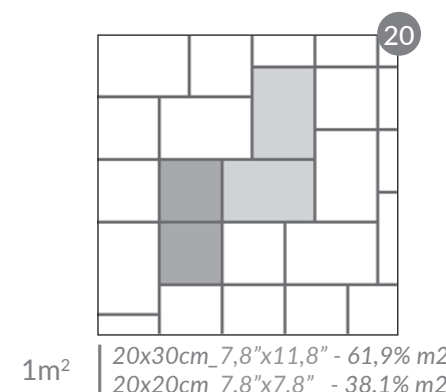
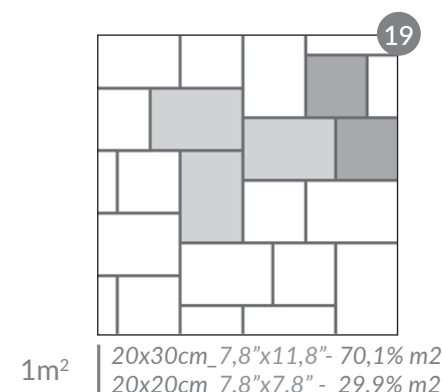
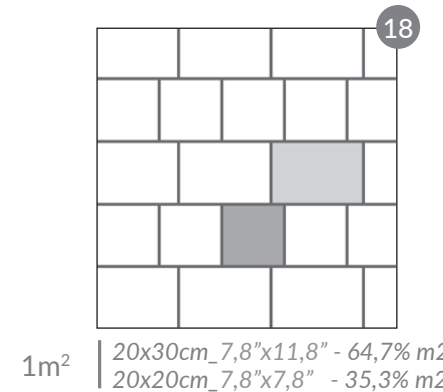
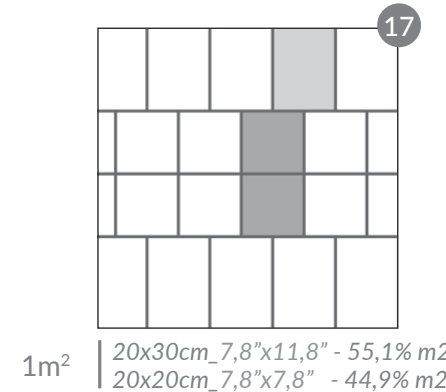
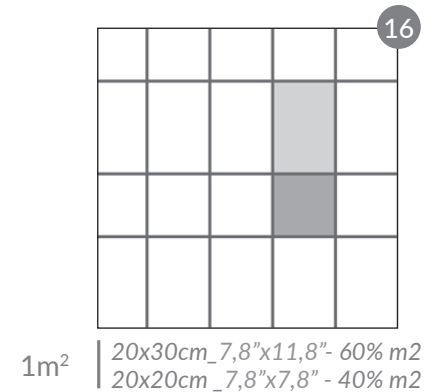
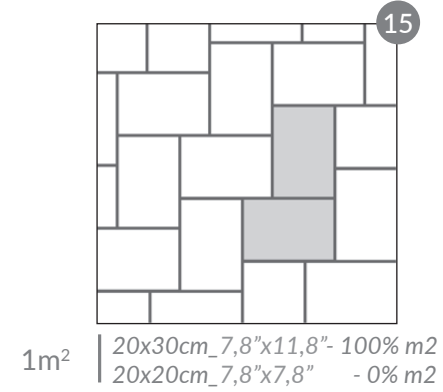
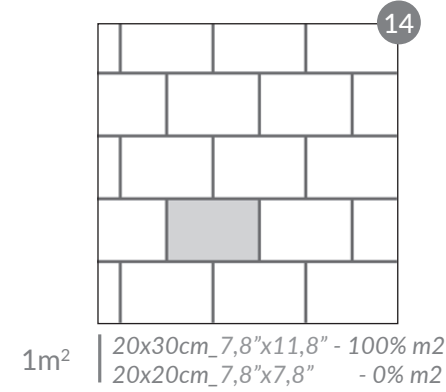
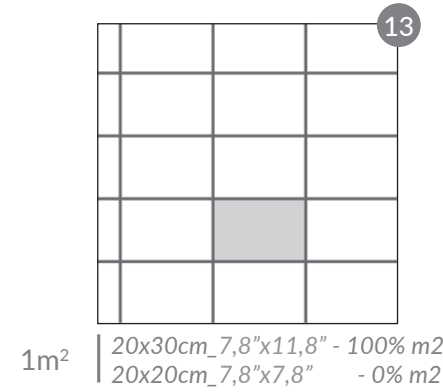

FORMAT SCHEMES 7,8"x7,8" & 7,8"x11,8"

ESQUEMAS FORMATO 20x30 cm y 20x20 cm

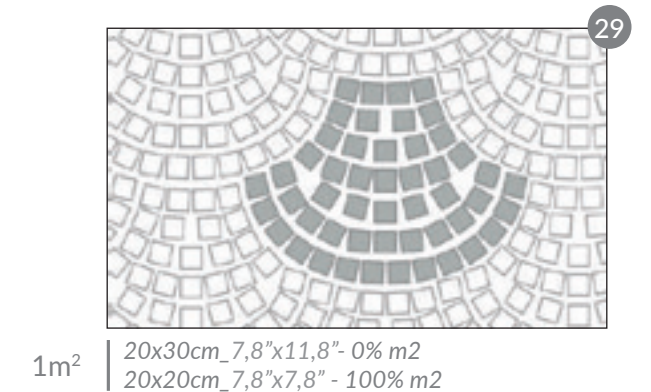
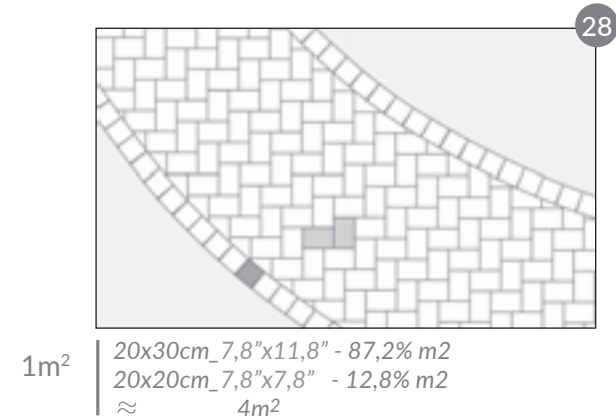
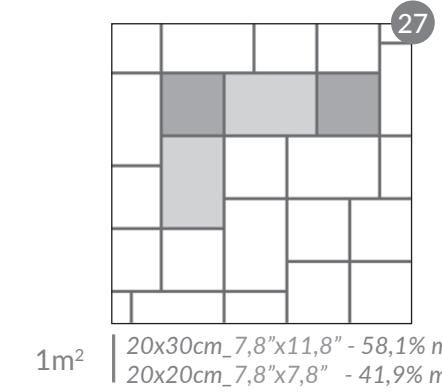
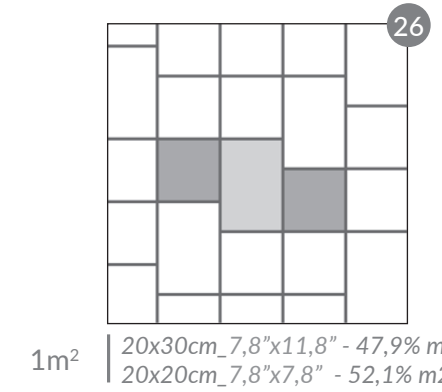
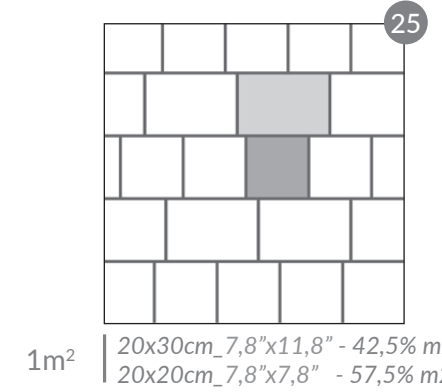

RECTANGULAR FORMAT WOODS

FORMATO RECTANGULAR MADERAS

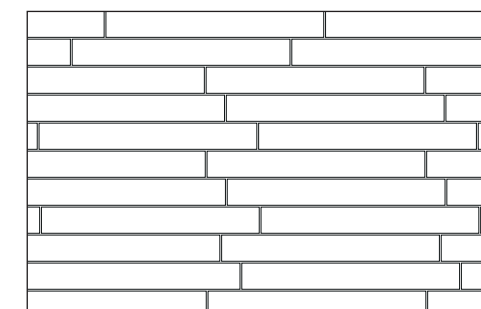

Locked laying (up to 12 cm.)
Colocación trabada (hasta 12 cm)

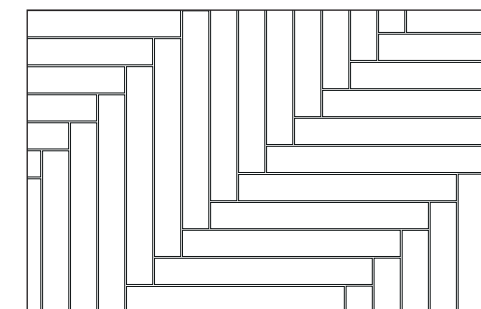

90° herringbone laying.
Colocación en espiga 90°

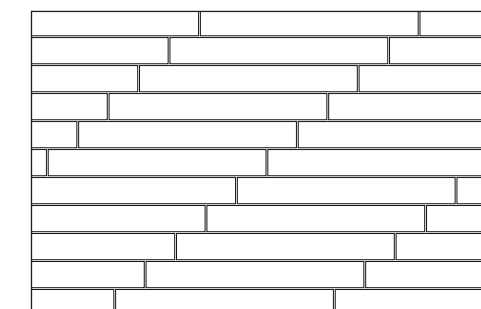

Regular laying (maximum separation 12 cm)
Colocación regular (separación máxima 12 cm)

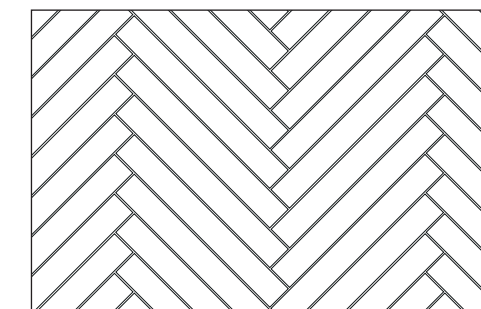

45° herringbone laying
Colocación en espiga 45°

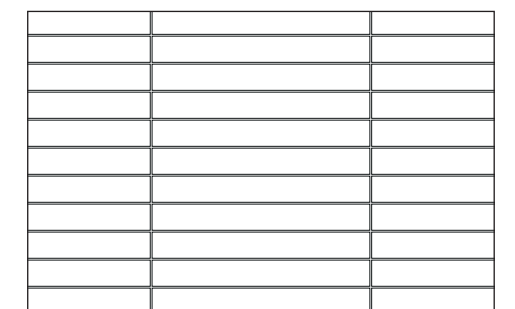

Regular laying.
Colocación regular.

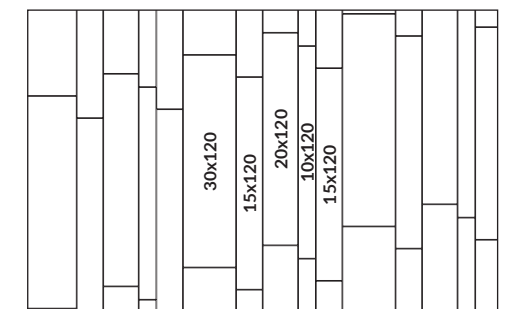

Multi 1 laying example
Ejemplo de colocación Multi 1

Installation instructions

Ceramic tiles

1. Installation of ceramic tiles should be carried out by skilled personnel, with demonstrable experience and appropriate tools and equipment, (i.e. toothed trowels, tile spacers, rubber mallets and suction cups for installation, and rubber trowels, sponges and containers for grouting). Check the information contained on the packaging beforehand, and meticulously follow the manufacturer's recommendations.

2. Check that the substrate to be covered is stable and the base is suitable for installing ceramic tiles: rough texture, not friable completely flat and level. We recommend that all damp areas are waterproofed.

3. Surfaces to be tiled must be completely free of dust or any other substance which could impair tile adhesion. For specific installations (radiant heating systems, façades with mechanical anchors, ceramics on roofs/ceilings or particular design constraints) request additional information specifically for each application.

4. The workplace must be adequately lit to detect possible installation defects easily, especially lippage between tiles. Electric site lighting is recommended, to provide brighter than normal light.

5. Choose the type of adhesive depending on the conditions and tiles used. The choice of tile and adhesive are critical to the subsequent performance of the entire work. Factors to take into account are: the type of ceramic material, tile format, substrate and end use (any traffic it will be subjected to, safety requirements in respect of falls...)

6. The only fixing system recommended is installation on a thin layer using a toothed trowel. A double bonding technique (with adhesive applied to both the substrate and the back of the ceramic tile) is recommended for tiles with a format larger than 1,000 cm². It is essential to remove any traces of bonding material that may remain on the surface of the tile prior to setting, ensuring that the joint is left clean to make grouting easier. Do not use metal tools or blunt elements in cleaning operations that could damage the surface of the tiles.

7. Great care should be taken when handling to avoid scratching, breaking or chipping the tiles, especially rectified tiles. Prior to installation, check that the tiles are free from defects.

8. Grout joints should be at least 1,5mm for interior flooring and 5mm for exterior paving. For installations with offset joints, stagger the tiles at the 3/4 point. Self-levelling tile spacers are recommended.

*Before using the system of anti-leveling crossings, perform a preliminary test with the type of wall tiles or floor tiles to be placed and check that during the breakage process of the separator, the tile is not damaged especially in embossed or rectified tiles without beveling. Consult the national standards of placement and respect the minimum joint width indicated for the type of tile and installation to be carried out.

9. Follow manufacturer's recommendations in respect of the preparation and use of adhesives. Do not apply adhesive at a thickness greater than indicated on the label, check the wetting capacity of the adhesive and press the ceramic tile into the bonding material with a side to side movement. Distribute the adhesive evenly under the tile. Different thicknesses may produce lippage defects caused by differential shrinkage of the bonding material. When positioning adjacent to previously installed ceramic tiles, estimate possible shrinkage and compensate for this.

10. Edge joints occurring at corners, changes of paving level and changes of material should be covered with tile trim or a tile itself and sealed with flexible sealant. Minimum joint width: 8 mm.

11. Take account of structural joints. Movement joints should be positioned as directed by the project designer. In general, do not design areas greater than 50-70 m² for interiors and half that for exteriors. Minimum joint width: 8 mm.

12. Both during installation and at the end of the day, check the quality of the work carried out before the bonding material sets. Correct any defects using suction cups and rubber mallets.

13. Prior to grouting, check that the bonding material has hardened. Remove the tile spacers, clean the joints along their length, width and depth, and check the joint is not damp.

14. Joints should be grouted when the tiles are completely fixed to the substrate. In respect of paving, follow the recommendations of the adhesive manufacturer to ensure sufficient time is allowed before the floor is walked on or subjected to load. In this way movement and/or breakages are avoided.

15. Follow the manufacturer's recommendations in respect of the preparation and use of grouting materials. Ensure that the material and tools chosen do not damage the tile surface. The grout should be applied using a rubber trowel.

16. Wait for the grout to start to dry, then clean with a sponge dampened in clean water. Do not allow the grout to harden on the tile, especially on textured tiles. Do not soak the joint with excess water.

17. Protect the paving against premature loading, other construction work and adverse weather. We recommend covering the paving with sheets or boards to avoid a build-up of dirt and to protect from scratches, abrasion and impact.

18. For cleaning, use products compatible with the chemical resistance of the tiles. Do not use strong detergents containing abrasives or cleaning agents containing hydrofluoric acid (HF). This acid attacks the glazing and will cause irreparable damage to the tiles.

Instrucciones de instalación

Baldosas cerámicas

1. La colocación de cerámica requiere de personal cualificado, con experiencia demostrada y herramientas y útiles adecuados: llanas dentadas, crucetas, mazas de goma, ventosas para la colocación y llanas de goma, esponjas y cubetas para el rejuntado. Revisar previamente la información contenida en los embalajes y respetar escrupulosamente las recomendaciones del fabricante.

2. Comprobar que el soporte que se va a revestir sea estable y el fondo de colocación adecuado para la colocación de cerámica: superficie con textura rugosa no disgregable, perfectamente nivelada y sin defectos de planitud. Se recomienda la impermeabilización de ambientes húmedos.

3. La superficie a revestir debe estar totalmente limpia de polvo o cualquier otra sustancia que pueda perjudicar la adhesión de las baldosas. Para colocaciones específicas (sistemas de calefacción radiante, fachadas con anclajes mecánicos, cerámica en techos ó resolución de parámetros particulares de proyecto) solicitar información concreta adicional para cada situación.

4. La iluminación del lugar de trabajo ha de ser lo suficientemente intensa como para detectar con facilidad cualquier defecto de colocación, especialmente "cejas" entre baldosas. Se recomienda trabajar con focos eléctricos y una iluminación superior a la de uso.

5. Elegir el tipo de adhesivo en función del ambiente y baldosa a revestir. La elección de la baldosa y del adhesivo son críticos en el comportamiento posterior del conjunto. Los factores a tener en cuenta son: tipo de material cerámico, formato de la baldosa, soporte de colocación y destino de uso (tráfico al que va ser sometido, requisitos de seguridad frente a caídas, ...).

6. El único sistema de colocación recomendado es la colocación en capa fina y llana dentada. En baldosas con formato superior a 1.000 cm², se recomienda la técnica de doble encolado, con aplicación del adhesivo tanto sobre el soporte como en el dorso de la baldosa cerámica.

Es fundamental retirar los restos de material de agarre que puedan quedar sobre la superficie de la baldosa antes de su fraguado, asegurándose de dejar la junta limpia para facilitar las labores de rejuntado. No utilizar herramientas metálicas

ni elementos contundentes en operaciones de limpieza que puedan deteriorar la superficie de las baldosas.

7. Todas las baldosas cerámicas y en especial las rectificadas, deben manipularse con el máximo cuidado, para evitar su rayado, despuntado o desconchado. Antes de iniciar la colocación, comprobar que la baldosa no presente ningún defecto. Verificar tono y calibrar antes de instalar.

8. Las juntas de colocación serán de al menos 1,5 mm en colocaciones interiores y 5 mm en pavimentos exteriores. En colocaciones a junta trabada, realizar la colocación a 3/4 de pieza. Se recomienda el uso de crucetas autonivelantes.

*Antes de utilizar el sistema de crucetas antinivelantes, realizar una prueba previa con el tipo de revestimiento o pavimento a colocar y comprobar que durante el proceso de rotura del separador no se daña la baldosa, especialmente en azulejos con relieve o rectificadas sin biselar. Consultar las normas de colocación nacionales y respetar el ancho de junta mínimo indicado para el tipo de baldosa e instalación a realizar.

9. Respetar las recomendaciones del fabricante en la preparación y utilización de los adhesivos. No aplicar el adhesivo en un espesor final superior al indicado en el saco, comprobar la capacidad humectante del adhesivo y presionar la cerámica sobre el material de agarre mediante un movimiento de vaivén. Distribuir el adhesivo de forma homogénea bajo la baldosa. Espesores diferentes pueden producir defectos tipo "ceja" por retracción diferencial del material de agarre. Cuando deba continuarse una colocación a partir de una cerámica ya colocada, estimar la posible retracción y tomar un nivel que la compense.

10. Las juntas perimetrales estarán presentes en esquinas, cambios de plano del pavimento y cambios de material. Se recomienda cubrir con el zócalo o la propia baldosa y sellar con una masilla elástica. Anchura mínima de la junta: 8mm.

11. Respetar las juntas estructurales. Realizar las juntas de movimiento según las indicaciones del técnico de la obra. En general, no diseñar áreas superiores a 50-70 m² en interiores y la mitad en exteriores. Anchura mínima de la junta: 8 mm.

12. Tanto durante la fase de colocación como antes de finalizar la jornada, revisar la calidad del trabajo realizado antes de que el material de

agarre complete su tiempo de ajuste y corregir los efectos mediante el uso de ventosas y mazos de goma.

13. Antes de proceder al rejuntado, revisar que el material de agarre haya endurecido. Retirar los restos de crucetas, limpiar las juntas de colocación en toda su longitud, anchura y profundidad y finalmente, comprobar que no quede humedad en el interior de la junta.

14. El relleno de juntas se debe realizar cuando las baldosas se encuentren perfectamente adheridas al soporte. En el caso del pavimento, se deben respetar las recomendaciones del fabricante de adhesivos, con el fin de dejar transcurrir el tiempo suficiente antes de ser pisado o sometido a cualquier tipo de carga. Se pueden evitar así despegues o roturas prematuras.

15. Respetar las recomendaciones del fabricante en la preparación y utilización de los materiales de junta. Comprobar que el material y herramienta elegida no dañan la superficie de la cerámica. El material de rejuntado se aplicará con llana de goma.

16. En zonas de agua se debe utilizar material de rejuntado de naturaleza epoxi y cubrir los encuentros con bañera ó ducha con silicona para evitar filtraciones de agua que generan problemas de absorción y potenciales cambios de tonalidad y expansión por humedad.

17. Proteger el pavimento contra cargas prematuras, otros trabajos de obra y condiciones climáticas adversas. Se recomienda cubrir los pavimentos con láminas o paneles que eviten la acumulación de suciedad y protejan del rayado, la abrasión y golpes.

18. En la limpieza de obra, utilizar productos compatibles con la resistencia química de las baldosas. Evitar el uso de detergentes sólidos con partículas abrasivas, así como agentes de limpieza que contengan ácido fluorhídrico (HF). Este ácido ataca el esmalte y causa daños irreparables en la cerámica.

The placement technique recommended by BESTILE, S.L. and described in this document has been developed taking as reference the guidelines marked in the Ceramic tile Guide, edited by the Valencian Institute of Building. In any case, consult the national standards for laying and putting into service of ceramic tiles and follow their instructions.

Bestile S.L. declines any responsibility if the instructions set forth in this catalogue are not followed, as well as for any material once it has been installed.

La técnica de colocación recomendada por BESTILE S.L. y descrita en este documento se ha desarrollado tomando como referencia las directrices marcadas en la Guía de la Baldosa Cerámica, editada por el Instituto Valenciano de la Edificación. En todo caso, consultar las normas nacionales sobre colocación y puesta en servicio de revestimientos cerámicos y seguir sus indicaciones.

Bestile S.L. declina cualquier responsabilidad si no se siguen las instrucciones plasmadas en este catálogo, así como de cualquier material una vez colocado.

Cleaning and maintenance instructions

Ceramic tiles

1. HYGIENIC PERFORMANCE OF CERAMIC TILES

The manufacturing process for ceramic tiles includes firing at high temperature (around 1100°C-1200°C), and even higher temperatures in the case of porcelain tiles. This temperature causes chemical reactions between the different components in the tile body and the glaze, as well as physical transformations whose main results are the creation of a hard, compact and highly resistant structure, and the reaction and immobilisation of heavy metals, by forming compounds characterised by their high level of chemical inactivity.

As a result, it is impossible for any microorganisms to be present, as the high temperatures used during the manufacturing process make it impossible for them to survive.

If ceramic wall and floor tiles are correctly laid using suitable bonding and grouting materials for their type of use, they are the most effective, comfortable and safe alternative for maintaining correct levels of hygiene and cleanliness.

Their impermeable surface prevents the absorption of any type of liquids, vapours, toxic substances or any other type of contaminant, as well as the production of reactions, putrefaction, efflorescence or organic cultures, due to their non-porous features.

Also, their chemical resistance means they are capable of withstanding aggressive detergents and disinfectants without any alteration, which could not be used with other types of wall and floor coverings.

The fact that they cannot become electrostatically charged means that they contribute towards physiological comfort and do not attract electrically charged dust in the atmosphere.

Ceramic tile surfaces are resistant to any type of adherence, and any substance that does become adhered due to the presence of materials such as grease or mud can be easily removed. This also applies to the hygienic properties of ceramic tiles in response to the deposition, accumulation and development of microorganisms and pathogenic or allergic substances.

2. PRECAUTIONS WHEN LAYING TILES.

a) Remnants of grouting material should be removed using a sponge dampened with clean water. The material should be removed as soon as possible, as if it is in contact with the glazed surface for a prolonged period it will be difficult to remove, especially on tiles with a relief patterned surface.

b) When laying floor tiles, it is essential to protect the tiles that have already been laid using a suitable method, to prevent damage caused by abrasive material and dragging tools across the surface. Apart from protecting the surface of the tiles, this will make any subsequent cleaning processes easier.

c) Do not use cleaning agents that contain hydrofluoric acid or solid detergents that contain particles that may scratch the material. Hydrofluoric acid will completely remove the glazed surface of

the material, causing irreparable damage.

3. MAINTENANCE TIPS

Glazed porous as well as unglazed non-porous floor and wall tiles do not need any type of maintenance once they have been laid. From all of the different types of materials and products used as wall and floor coverings, ceramic tiles have the least maintenance requirements.

Regardless of the type of glaze, intrinsic features such as resistance to surface abrasion or scratching are directly associated with the abrasive agent between the tiles and the sole of the footwear moving over them. To avoid premature wear, floors must be kept clean, placing mats at the entrance to premises with direct access from the street or gardens.

For ordinary cleaning, a damp mop or sponge is recommended. The cleaning water must be renewed frequently so that the previously removed dirt is not deposited on the surface again. It is advisable to use neutral cleaning products.

Glazed wall and floor tiles only require normal cleaning with a mop or damp sponge to return them to their original appearance, plus neutral cleaning product.

Cleaning agents containing waxes should not be used, as they will eventually form a film over the tile that will make them susceptible to absorbing and retaining foreign substances, causing stains that are highly visible and more difficult to eliminate using ordinary cleaning methods.

In bathrooms, where remnants of soap or lime scale can accumulate, tiles should be cleaned regularly with a suitable detergent product, leaving it to act for a few minutes before rinsing.

REMOVING DIFFICULT STAINS AND INCRUSTATIONS.

To remove difficult stains, for example on surfaces that have not been cleaned for some time, powdered or liquid detergents should be used, rubbing with a sponge or scourer.

Special attention should be paid to the tile joints, as they must be restored if they are no longer intact or waterproof, using appropriate sealants.

Metallic blades or spatulas should not be used on glazed tile surface, or concentrated products when you do not know the chemical resistance rating of the wall or floor tiles.

Accidents can cause ceramic wall or floor tiles to become stained with different types of substances. Stains and incrustations can be removed using physical and chemical methods, using the most suitable method for the type of tile and the type of stain.

The physical methods involve using detergents or very fine abrasives, which physically remove the stain from the tile surface.

The chemical methods are based on a chemical reaction between the stain or incrustation and the detergent that dissolves it or discolours it.

Only use concentrated acids on glazed tiles if their composition is known, as certain types may affect the tile surface.

The table at the end shows some examples of suitable products for treating specific stains. If

the type of stain is unknown, different detergents should be tested, rinsing the surface with water and drying it after each test.

In other cases, it may be effective to repeat the treatment several times or use hot water to help with the reaction.

Removing difficult stains and incrustations. To remove difficult stains, for example on surfaces that have not been cleaned for some time, powdered or liquid detergents should be used, rubbing with a sponge or scourer. Special attention should be paid to the tile joints, as they must be restored if they are no longer intact or waterproof, using appropriate sealants.

In any event, if you have any doubts whatsoever, consult the technical data sheet for the product.

Also, when carrying out any unconventional cleaning method, first test a small zone before applying the treatment to the whole surface, checking the reaction.

Cementitious adhesive	Acid detergent
Coffee, tea, food, fruit, juice or cosmetics	Normal detergent dissolved in hot water
Greases	Baking soda and water, neutral soap (use a mild scouring pad)
Pencil stains	Soft eraser
Organic stains	Alkaline detergent
Marker paint	Solvent (turpentine, acetone, ethanol)
Rubber remnants	Alkaline detergent, solvent
Gasket remnants	Acid detergent
Silicone remnants	Hydrogen peroxide or diluted bleach solution (on smooth surfaces not susceptible to scratching, a vitroceramic scraper can be used)
Bloods	Hydrogen peroxide or diluted bleach solution
Inks	Diluted bleach solution
Iodine or bromine	Acid detergent, hydrogen peroxide, diluted bleach solution, ammonia

Instrucciones de limpieza y mantenimiento

Baldosas cerámicas

1. COMPORTAMIENTO HIGIÉNICO DE LAS BALDOSAS CERÁMICAS

El proceso de fabricación de las baldosas cerámicas comprende entre sus etapas, una cocción a alta temperatura (del orden de 1100°C-1200°C), e incluso superiores en el caso de porcelánico. Esta temperatura produce reacciones químicas entre los diferentes componentes de la pasta y la decoración así como transformaciones físicas cuyas principales consecuencias son la formación de una estructura dura, compacta y resistente y la reacción e inmovilización de los metales pesados al formarse compuestos que se caracterizan por su alta inactividad química.

Por ello, la presencia de cualquier microorganismo queda descartada al someter al producto durante su fabricación a regímenes de temperatura que hacen imposible su supervivencia.

Los revestimientos y pavimentos cerámicos, si están correctamente instalados (con los materiales de agarre y rejuntado apropiados a su función de uso), representan la alternativa mas eficaz, cómoda y segura para mantener las condiciones adecuadas de higiene y limpieza.

Su superficie impermeable, evita la intromisión de líquidos, vapores, sustancias tóxicas o cualquier otro contaminante: evita a su vez, la generación de reacciones, putrefacciones, eflorescencias o cultivo orgánico por sus características no porosas.

Por otra parte, su resistencia química, les hace susceptibles de soportar, sin sufrir alteración, productos detergents y desinfectantes agresivos, difícilmente utilizable sobre otros materiales de revestimiento y pavimento. Así mismo, por su equipotencialidad eléctrica y la no predisposición al acumulo de cargas electrostáticas, los revestimientos cerámicos contribuyen al confort fisiológico y evitan la captación del polvo ambiental eléctricamente activo.

La naturaleza de la superficie cerámica evita cualquier fenómeno de adherencia y si ésta se produce por medio de un vehículo intermedio (grasa, barro, etc.) es fácilmente eliminable. Este mismo razonamiento sirve para exaltar las positivas propiedades higiénicas del producto cerámico respecto al depósito, acumulación y anidación de microorganismos y sustancias patógenas y alérgicas.

2. PRECAUCIONES DURANTE LA COLOCACIÓN.

a) La retirada de los restos de material de rejuntado se debe realizar utilizando una esponja humedecida en agua limpia. Esta operación no se debe prolongar en el tiempo, ya que un excesivo tiempo de contacto con la superficie esmaltada, dificulta la posterior eliminación del mismo, en especial aquellos modelos que su superficie presenta relieves.

b) Se hace imprescindible, en la colocación del pavimento, la protección del material ya colocado con sistemas adecuados, para impedir posibles daños hasta la finalización de la obra, debido a la presencia de material abrasivo y continuo trasiego de herramientas. De esta forma, además de la protección de la superficie cerámica, se facilitan así las posteriores tareas de limpieza.

c) Se deben evitar agentes de limpieza que contengan ácido fluorhídrico (HF) y detergents sólidos que contengan partículas susceptibles de abrasionar el material. El ácido fluorhídrico eliminaría totalmente la superficie esmaltada del material, causando así daños irreparables.

3. CONSEJOS DE MANTENIMIENTO

Los pavimentos y revestimientos cerámicos porosos vidriados y los no porosos sin vidriar no necesitan

ningún mantenimiento después de concluir todas las operaciones de puesta en obra. De entre todos los materiales y productos empleados como revestimientos y pavimentos, la cerámica es la que presenta menores exigencias en este campo. Con independencia de las características del vidriado, características intrínsecas como la resistencia a la abrasión superficial o al rayado, vienen directamente relacionadas con el agente abrasivo que se coloca como fase intermedia entre el pavimento y la suela del calzado que transita sobre éste. Para evitar desgaste prematuro, es recomendable mantener los suelos debidamente limpios, a lo que ayuda sobremanera la colocación de alfombras en la entrada a locales con acceso directo desde la calle o el jardín.

Para devolver el aspecto superficial original a los pavimentos y revestimientos vidriados, es suficiente una pasada con mocho o esponja humedecida en agua y detergente neutro.

Si con el transcurso del tiempo, se observa una superficie de aspecto plástico con mayor dificultad para mantenerse limpia, de forma general, suele deberse a la formación de una capa superficial. Esa capa resulta difícil de eliminar con la fregona convencional. Para eliminarla y conseguir la superficie original, se debe emplear una disolución ligeramente ácida (añadir sulfuman en una proporción del 5% en agua) y ejercer una rotación más intensa (cepillo de púas de plástico duro). Aclarar posteriormente con suficiente agua para eliminar la suciedad desincrustada.

Para la limpieza ordinaria, se recomienda utilizar fregona o esponja humedecida. Es necesario renovar el agua de limpieza frecuentemente, para no volver a depositar sobre la superficie la suciedad eliminada con anterioridad. Es aconsejable utilizar productos de limpieza de carácter neutro.

El empleo de un mocho de microfibras y agua muy caliente favorecerá el secado de la superficie y minimizará la creación de una capa superficial sobre la baldosa, hecho que facilita el posterior marcado de las huellas y una mayor propensión a captar la suciedad.

No conviene utilizar agentes de limpieza que contengan ceras en su composición, ya que terminan formando una película sobre la baldosa cerámica que favorece la absorción y retención de sustancias extrañas, originando manchas fácilmente detectables y más difíciles de eliminar con las operaciones de limpieza ordinarias.

Si es el caso del baño, donde se suelen formar incrustaciones de jabón o de carbonatos del agua, conviene efectuar limpiezas periódicas con un producto detergente adecuado, dejándolo en reposo durante unos minutos antes de proceder a su eliminación.

ELIMINACIÓN DE MANCHAS E INCRUSTACIONES EXTRAORDINARIAS.

Para limpiezas extraordinarias, por ejemplo las que son necesarias sobre superficies que han estado abandonadas de la limpieza durante mucho tiempo, se deben emplear detergents en polvo o líquidos, aplicados frotando con una esponja o estropajo.

Especial atención merece las juntas entre baldosas, que deberán restaurarse en caso de falta de integridad o estanqueidad, con sellantes adecuados. No es aconsejable la utilización de cuchillas o espátulas metálicas sobre la superficie vidriada y tampoco es aconsejable el uso de productos concentrados cuando no se posea seguridad sobre la clase de resistencia química del revestimiento o pavimento.

Accidentalmente, nos podemos encontrar con que el pavimento o revestimiento cerámico se manche por acción de alguna o algunas sustancias de diversas

naturaleza. Existen procedimientos físicos y químicos para la eliminación de manchas e incrustaciones, debiéndose adoptar el más idóneo al tipo de baldosa y naturaleza de la mancha.

Los métodos físicos se basan en la utilización de detergents o abrasivos de gran finura, cuya función es el despegue físico de la mancha y el alejamiento de la superficie cerámica.

Los métodos químicos se basan en la reacción química entre la mancha o incrustación y el detergente que la disuelve o decolora. En baldosas vidriadas no es aconsejable usar ácidos concentrados de naturaleza desconocida y que puedan atacar la superficie, por desconocerse su resistencia química.

En la tabla del final, y a modo de ejemplo, se exponen algunos productos adecuados para el tratamiento de determinadas manchas. Cuando no se conozca la naturaleza de la mancha conviene realizar pruebas con detergents diferentes, enjuagando la superficie con agua y secándola después de cada prueba. En otros casos, puede resultar eficaz repetir el tratamiento varias veces o emplear agua caliente para favorecer la reacción.

En cualquier caso, y ante la más mínima duda, conviene consultar la ficha técnica del producto.

Restos de silicona: Cuchilla para limpiar vitrocerámica en superficies lisas y que no sean susceptibles de rayado. Para superficies con relieve o brillantes delicadas frente al rayado, se puede utilizar una mezcla de acetona y éter a partes iguales, aplicar sobre la silicona y esperar a que se desprenda.

Marcas de costilla (dorso de la pieza) sobre la superficie cerámica: Alúmina en polvo disuelta en agua y ayudarse de máquina rotativa con disco 3M. Las características del disco deben ser elegidas en función de la resistencia superficial.

No se deben emplear en la limpieza periódica sistemas rotativos o mecánicos con abrasivos de distinta naturaleza, ya que pueden modificar el brillo inicial en distinta medida, según intensidad del tratamiento e incluso en condiciones extremas, según presión y abrasivo utilizado, deteriorar la superficie cerámica.

Igualmente, al efectuar cualquier método de limpieza que se desvíe del convencional, conviene realizar un ensayo previo en una zona concreta antes de aplicar el tratamiento sobre toda la superficie. Así, nos aseguraremos de la inercia o reactividad de la superficie cerámica ante tal método.

Adhesivo cementoso	Detergente ácido
Café, té, alimentos, fruta, zumo o cosméticos	Detergente normal disuelto en agua caliente
Grasas	Bicarbonato y agua, jabón neutro (utilizar estropajo suave)
Manchas de lápiz	Goma de borrar blanda
Manchas orgánicas	Detergente alcalino
Pintura de rotulador	Disolvente (aguarrás, acetona, etanol)
Restos de goma	Detergente alcalino, disolvente
Restos de junta	Detergente ácido
Restos de silicona	Agua oxigenada o solución diluida de lejía (en superficies lisas y no susceptibles de rallado, puede utilizarse raspador de vitrocerámica)
Sangre	Agua oxigenada o solución diluido de lejía
Tintas	Solución diluida de lejía
Yodo o bromo	Detergente ácido, agua oxigenada, solución diluida de lejía, amoniaco

CTE. Spanish Building Code

CTE. Código Técnico de la Edificación

“Safety of Use” Basic Document 1 (“DB SU 1 – Preventing Falls”) of the Spanish Building Code (the CTE in Spanish) defines the requirements that a floor covering must meet in buildings or areas used for health-related, educational, commercial, administrative or public purposes or for parking (excluding areas of restricted use). To comply, the flooring must achieve a minimum slip resistance (Rd) value. The slip resistance value “Rd” is determined by means of the pendulum test described in Annex C of the UNE EN 16165: 2022 standard.

The following table shows the rating system for flooring, depending on its slip resistance:

El CTE, Código Técnico de la Edificación, dentro de su Documento Básico de seguridad de Utilización 1 “DB SU 1 - seguridad frente al riesgo de caídas”, define los requisitos que debe cumplir un suelo para poder ser utilizado como pavimento de los edificios o zonas de uso sanitario, docente, comercial, administrativo, aparcamiento y pública concurrencia (excluidas las zonas de uso restringido). Para ello, el pavimento deberá cumplir con un valor mínimo al deslizamiento “Rd”.

El valor de resistencia al deslizamiento “Rd”, se determina mediante el ensayo del péndulo descrito en el anexo C de la normativa UNE EN 16165: 2022.

La siguiente tabla establece la clasificación de los suelos según su resbaladidad:

SLIP RESISTANCE RD RESISTENCIA AL DESLIZAMIENTO RD	CLASS CLASE
Rd < 15	0
15 < Rd < 35	1
35 < Rd < 45	2
Rd > 45	3



RATING REQUIRED FOR FLOORING DEPENDING ON ITS LOCATION / CLASE EXIGIBLE A LOS SUELOS EN FUNCIÓN DE SU LOCALIZACIÓN

LOCATION AND CHARACTERISTICS OF THE FLOOR LOCALIZACIÓN Y CARACTERÍSTICAS DE SUELO	CLASS CLASE
DRY INDOOR AREAS / ZONAS INTERIORES SECAS: SURFACES WITH A SLOPE OF LESS THAN 6% SUPERFICIES CON PENDIENTE MENOR QUE EL 6% SURFACES WITH A SLOPE EQUAL TO OR HIGHER THAN 6% AND STAIRS SUPERFICIES CON PENDIENTE IGUAL O MAYOR QUE EL 6% Y ESCALERAS	1 2
INDOOR AREAS SUBJECT TO MOISTURE, SUCH AS ENTRANCES TO BUILDINGS FROM OUTDOOR AREAS (1), COVERED TERRACES AND BALCONIES, CHANGING ROOMS, BATHROOMS, CLOAKROOMS, KITCHENS ETC: ZONAS INTERIORES HÚMEDAS, TALES COMO LAS ENTRADAS A LOS EDIFICIOS DESDE EL ESPACIO EXTERIOR (1), TERRAZAS CUBIERTAS, VESTUARIOS, BAÑOS, ASEOS, COCINAS, ETC.:	2 3
OUTDOOR AREAS. SWIMMING POOLS. SHOWERS (2) ZONAS EXTERIORES, PISCINAS, DUCHAS (2)	3

(1) EXCEPT FOR ACCESSES THAT LEAD DIRECTLY TO AREAS OF RESTRICTED USE .

(1) EXCEPTO CUANDO SE TRATE DE ACCESOS DIRECTOS A ZONAS DE USO RESTRINGIDO

(2) IN PLACES WHERE USERS ARE EXPECTED TO GO BAREFOOT AND IN THE BOTTOM OF SWIMMING POOLS IN AREAS WITH A DEPTH OF LESS THAN 1.50 M.

(2) EN ZONAS PREVISTAS PARA USUARIOS DESCALZOS Y EN EL FONDO DE LOS VASOS, EN LAS ZONAS EN LAS QUE LA PROFUNDIDAD NO EXCEDA DE 1.50 M.

THIS RATING IS MAINTAINED THROUGHOUT THE USEFUL LIFE OF THE FLOORING.

DICHA CLASE SE MANTENDRÁ DURANTE LA VIDA ÚTIL DEL PAVIMENTO.

SLIP RESISTANCE, DYNAMIC COEFFICIENT OF FRICTION

In the american market, the assessment of the anti-slip performance is carried out through a mobile robot (bot 3000).

This unit travels on the surface being tested (wetted previously) and determines its resistance in response to the unit’s movement.

The EEUU standards (ansi standard) require a dcof value ≥ 0.42 For surfaces which are susceptible of getting wet.

RESISTENCIA AL DESLIZAMIENTO, COEFICIENTE DE FRICCIÓN DINÁMICO (DCOF)

La valoración de la prestación antideslizante en el mercado americano se lleva a cabo a través de un robot móvil (bot 3000).

Este equipo circula sobre la superficie a testar (previamente mojada) y determina la resistencia de la misma al movimiento del equipo.

La normativa en Estados Unidos (norma ansi) requiere un valor dcof ≥ 0.42 Para superficies susceptibles de estar mojadas.

Slip resistance according to Annex B of standard EN 16765:2022

Resistencia al deslizamiento

Many European flooring manufacturers use tests like the ramp test to rate their products according to their slip resistance. These tests are generally conducted using Annex B of standard EN 16165: 2022. With this method, a person walks backwards and forwards on an impregnated ramp-type floor used as a test bench. The angle of the ramp is gradually increased until the person slips. The average angle at which the person slips is used to calculate the CoF (coefficient of friction). Annex B of EN 16165: 2022 uses safety boots and engine oil as a substance to impregnate the surface to be tested, which are described in the standard itself.

Muchos fabricantes europeos de suelos, usan ensayos del tipo de la rampa para clasificar sus productos en función del grado de deslizamiento. Estos ensayos se llevan a cabo generalmente, usando el anexo B de la normativa EN 16165: 2022. El método implica el uso de sujetos que caminan adelante y atrás, a través de un suelo impregnado y utilizado como banco de ensayos en forma de rampa. El grado de inclinación de la rampa se va incrementando gradualmente hasta que el sujeto que está ensayando, resbala. El ángulo medio de inclinación al que el sujeto resbala, es utilizado para calcular el CoF (Coeficiente de fricción). El anexo B de la normativa EN 16165: 2022 utiliza unas botas de seguridad y aceite de motor como sustancia que impregne la superficie a ensayar, que se describen en la propia norma.

TOTAL MEAN VALUE OF SLIP ANGLE VALOR TOTAL MEDIO DEL ÁNGULO DE CAIDA	RATING GRUPO DE CLASIFICACIÓN
6° <= Ángulo <= 10°	R9
10° < Ángulo <= 19°	R10
19° < Ángulo <= 27°	R11
27° < Ángulo <= 35°	R12
35° <= Ángulo	R13



SLIP RISK ASSESSMENT TABLE / TABLA DE VALORACIÓN DE RIESGO DE DESLIZAMIENTO

PREMISES AND WORK AREAS / LOCALES Y ÁREAS DE TRABAJO	APPROXIMATE VALUE VALOR ORIENTATIVO
TYPES OF PREMISES AND WORK AREAS / LOCALES Y ÁREAS DE TRABAJO GENERALES ENTRANCES / ENTRADAS (*) STAIRS / ESCALERAS (**) COMMUNAL AREAS (TOILETS, LAUNDRIES, ETC) / ESPACIOS COMUNES (LAVABOS, LAVADEROS, ETC) MEETING ROOMS / SALAS DE REUNIÓN AREAS FOR HEALTH-RELATED USE / ÁREAS DE USO SANITARIO	R9 R9 R10 R9 R9
KITCHENS, DINING ROOMS / COCINAS, COMEDORES HOSPITALITY-INDUSTRY KITCHENS (RESTAURANTS AND HOTELS) / COCINAS GASTRONÓMICAS (RESTAURANTES Y HOTELES) UP TO 100 DINERS A DAY / HASTA 100 CUBIERTOS POR DÍA OVER 100 DINERS A DAY / MÁS DE 100 CUBIERTOS POR DÍA COOPERATIVE-TYPE KITCHENS IN RESIDENCES, SCHOOLS OR NURSING HOMES / COCINAS COOPERATIVAS EN RESIDENCIAS, COLEGIOS, SANATORIOS COOPERATIVE-TYPE KITCHENS IN HOSPITALS AND CLINICS / COCINAS COOPERATIVAS EN HOSPITALES Y CLÍNICAS LARGE COOPERATIVE-TYPE KITCHENS AT TRADE FAIRS AND IN CANTEENS AND MOBILE KITCHENS / GRANDES COCINAS COOPERATIVAS EN FERIAS, CANTINAS Y MÓVILES FAST-FOOD KITCHENS / COCINAS PARA COMIDA RÁPIDA KITCHENS FOR HEATING UP PRECOOKED FOOD / COCINAS PARA CALENTADO DE COMIDAS PREPARADAS TEAROOMS AND COFFEE SHOPS / SALAS DE CAFÉ Y TE DINING ROOMS, CLIENT ROOMS, AND CANTEENS INCLUDING CORRIDORS LEADING TO THEM / COMEDORES, SALAS DE CLIENTES, CANTINAS INCLUIDOS PASILLOS DE SERVICIO	R11 R12 R11 R12 R12 R12 R10 R10 R9
FACILITIES USED FOR HEALTH SERVICES / LOCALES DE LOS SERVICIOS SANITARIOS THERMAL SPAS, AND HYDROTHERAPY AND MUD-TREATMENT FACILITIES / BAÑOS TERMALES, HIDROTHERAPIA Y FANGOS BATHING AREAS / ZONAS DE BAÑO HEALTH FACILITIES, SPAS / ZONAS SANITARIAS, ESTACIONES DE BAÑO AREAS FOR MEDICAL DIAGNOSTIC AND THERAPEUTIC PURPOSES, AND MASSAGE ROOMS / ZONAS DE DIAGNÓSTICO MÉDICO Y TERAPÉUTICO, SALAS DE MASAJE FLOORS CONTAINING ROOMS FOR PATIENTS AND CORRIDORS / PLANTAS CON HABITACIONES PARA ENFERMOS Y PASILLOS MEDICAL SURGERIES AND OUTPATIENT CLINICS / CONSULTORIOS MÉDICOS, AMBULATORIOS CHEMISTS / FARMACIAS LABORATORIES / LABORATORIOS	R11 R10 R10 R9 R9 R9 R9
GARAGES / GARAJES GARAGES (INDOOR OR UNDERGROUND), UNAFFECTED BY THE CLIMATE / GARAJES, (EN EDIFICIO O SUBTERRÁNEOS) SIN INFLUENCIA CLIMÁTICA OPEN-AIR CAR PARKS / PARKING AL AIRE LIBRE	R10 R11
SCHOOLS AND NURSERY SCHOOLS / COLEGIOS Y GUARDERÍAS ENTRANCES, CORRIDORS, REST AREAS / ENTRADAS, PASILLOS, ZONAS DE DESCANSO CLASSROOMS, ROOMS FOR GROUPS / AULAS, SALAS PARA GRUPOS STAIRS / ESCALERAS TOILETS / LAVABOS OUTDOOR TRANSIT AREAS / ZONAS DE TRANSITO EXTERIORES	R9 R9 R9 R10 R11

(*) ENTRANCES REFER TO PLACES WITH DIRECT ACCESS FROM THE OUTSIDE OF THE BUILDING WHERE WETNESS MIGHT BE BROUGHT INSIDE.

(*) LAS ENTRADAS SE REFIEREN A AQUELLAS ZONAS A LAS QUE SE PUEDE ACCEDER DIRECTAMENTE DESDE EL EXTERIOR Y EN DONDE LA HUMEDAD PUEDE LLEGAR O SER INTRODUCIDA DESDE EL EXTERIOR.

(**) STAIRS ONLY REFER TO ONES WHERE WETNESS MIGHT BE BROUGHT INSIDE FROM OUTSIDE THE BUILDING OR ONES LOCATED DIRECTLY AFTER ENTRANCES WITH DIRECT ACCESS FROM THE OUTSIDE.

(**) LAS ESCALERAS SE REFIEREN ÚNICAMENTE A AQUELLAS A LAS QUE PUEDE LLEGAR O SER INTRODUCIDA LA HUMEDAD DESDE EL EXTERIOR, COMO LAS SITUADAS DIRECTAMENTE A CONTINUACIÓN DE LAS ENTRADAS CON ACCESO DESDE EL EXTERIOR.

Technical features

Características técnicas

TECHNICAL CHARACTERISTICS CARACTERÍSTICAS TÉCNICAS	WHITE BODY WALL TILE REVESTIMIENTO PASTA BLANCA	GLAZED PORCELAIN STONEWARE PORCELÁNICO ESMALTADO	
	NORMA EN 14411: ISO 13006 GRUPO BIII	NORMA EN 14411: ISO 13006 GRUPO BIIb	NORMA EN 14411: ISO 13006 GRUPO BIa
	NORM VALUE VALOR DE LA NORMA	NORM VALUE VALOR DE LA NORMA	NORM VALUE VALOR DE LA NORMA
LENGTH AND WIDTH LONGITUD Y ANCHURA (ISO 10545-2)	Not rectified / No rectificado \pm 0,6% / Max \pm 2 mm Rectified / Rectificado \pm 0,3% / Max \pm 1 mm		
WEDGING ORTOGONALIDAD (ISO 10545-2)	Not rectified / No rectificado \pm 0,5% / Max \pm 2 mm Rectified / Rectificado \pm 0,3% / Max \pm 1,5 mm		
WARPAGE OF EDGES RECTITUD DE LOS LADOS (ISO 10545-2)	Not rectified / No rectificado \pm 0,5% / Max \pm 1,5 mm Rectified / Rectificado \pm 0,3% / Max \pm 0,8 mm		
THICKNESS ESPESOR (ISO 10545-2)	\pm 10% (Max \pm 0,5 mm)	\pm 5% (Max \pm 0,5 mm)	\pm 5% (Max \pm 0,5 mm)
FLATNESS PLANITUD DE LA SUPERFICIE (ISO 10545-2)	Not rectified / No Rectificado \pm 0,5% / Max \pm 2 mm Rectified / Rectificado \pm 0,4% / Max \pm 1,8 mm		
SURFACE QUALITY CALIDAD SUPERFICIAL (ISO 10545-2)	The surface quality is expressed as a percentage of tiles without defects. A minimum of 95% of the tiles are required to be free of visible defects. They must be examined from a distance of 1m and with an illumination of 300 lux. La calidad superficial se expresa como porcentaje de baldosas sin defectos. Se exige que un mínimo de 95% de las baldosas estén libres de defectos visibles. Deben examinarse desde una distancia de 1m y con una iluminación de 300 lux.		
WATER ABSORPTION ABSORCIÓN DE AGUA (ISO 10545-3)	E >10% Mínimo individual 9%	0,5 < E \leq 3% Máximo individual 3,3%	\leq 0,5 Máximo individual 0,6%
FORCE OF BREAKAGE FUERZA DE RUPTURA	(Thickness/Espesor) < 7,5 mm Mín. 200N (Thickness/Espesor) \geq 7,5 mm Mín. 600N	(Thickness/Espesor) < 7,5 mm Mín. 700N (Thickness/Espesor) \geq 7,5 mm Mín. 1100N	(Thickness/Espesor) < 7,5 mm Mín. 700N (Thickness/Espesor) \geq 7,5 mm Mín. 1300N
RESISTANCE TO THE FLEXION RESISTENCIA A LA FLEXIÓN	(Thickness/Espesor) < 7,5 mm 15N/mm ² (Thickness/Espesor) \geq 7,5 mm 12N/mm ²	\geq 30 N/mm ² Mínimo individual 27	\geq 35 N/mm ² Mínimo individual 32
THERMAL SHOCK CHOQUE TÉRMICO (ISO 10545-9)	PASSES STANDARD TEST PASA SATISFACTORIAMENTE EL ENSAYO		
RESISTANCE TO CRACKING RESISTENCIA AL CUARTEO (ISO 10545-11)	PASSES STANDARD TEST PASA SATISFACTORIAMENTE EL ENSAYO		
RESISTANCE TO STAINS RESISTENCIA A LAS MANCHAS (ISO 10545-14)	CLASS 3 MIN MÍNIMO CLASE 3		
ACIDS BASES ÁCIDOS Y BASES (ISO 10545-13)	DECLARED VALUE-ACCORDING TO MODEL VALOR DECLARADO - SEGÚN MODELO		
RESIDENTIAL (SWIMMING POOL) CHEMICLAS RESISTENCIA A LOS PRODUCTOS DE LIMPIEZA Y REACTIVOS DE PISCINAS (ISO 10545-13)	CLASS B MIN MÍNIMO CLASE B		
ABRASION RESISTANCE RESISTENCIA A LA ABRASIÓN (ISO 10545-7)	BY THE MANUFACTURER INDICADO POR EL FABRICANTE		
SLIP RESISTANCE RESISTENCIA AL DESLIZAMIENTO (UNE 16165 ANEXO A/B/C)	BY THE MANUFACTURER INDICADO POR EL FABRICANTE		

Packing list

Lista de embalaje

Size	Model	Pz Bx	Sqm Bx	Kg Box	Bx Pallet	Sqm Pallet	Kg Pallet
1,5x20 cm _ 0,6"x7,9"	PB Jolly Nolita	30 pz	0,09	1,11	234 bx	21,06	275
1,5x30 cm _ 0,6"x11,8"	PB Jolly Nara	30 pz	0,14	1,63	234 bx	32,76	396
5x25 cm _ 2"x9,8"	GPR Arlington, Bunbury, Downtown, Mago, Mailo	60 pz	0,75	13,50	75 bx	56,25	1.028
	GPR Ainsa	44 pz	0,55	14,00	75 bx	41,25	1.065
	PB Saona	60 pz	0,75	13,00	100 bx	75,00	1.314
5x50 cm _ 2"x19,7"	GPR Bunbury, Makalu, Nervia	30 pz	0,75	14,10	80 bx	60,00	1.143
6,5x20 cm _ 2,6"x7,9"	GPR Lewis, Magnetic, Musa, Nolita, Shade	28 pz	0,36	6,70	145 bx	52,20	986
7x30 cm _ 2,7"x11,8"	PB Chair Rail	13 pz	0,27	5,13	120 bx	32,40	631
7,5x30 cm _ 2,9"x11,8"	PB Nara	26pz	0,59	9,30	120 bx	70,80	1.131
7,5x30 cm _ 2,9"x11,8"	PB Iris, Tavira, Van	26pz	0,59	9,10	120 bx	70,80	1.107
10x30 cm _ 3,9"x11,8"	GPR Alma, Cocole	38 pz	1,14	21,12	51 bx	58,14	1.092
15x15 cm _ 5,9"x5,9"	GPR Alma, Altai, Atlantico, Bali,	25 pz	0,56	10,25	104 bx	58,24	1.081
	GPR Alabama	13 pz	1,15	20,99	60 bx	69,00	1.274
	GPR Hanko, Concept, Galdar	13 pz	1,15	21,96	60 bx	69,00	1.333
	GPR Baden, Bergamot	10 pz	0,89	16,27	60 bx	53,40	991
17x52 cm _ 6,7"x20,5"	GPR Milena	10 pz	0,89	20,69	60bx	53,40	1.256
	GPR Meraki	24 pz	0,84	18,00	48 bx	40,32	879
20x20x1,4 cm _ 7,8"x7,8"x0,6"	GPR Alsacia, Aran, Pierre, Porfido Tex	17 pz	0,68	22,10	60 bx	40,80	1.341
20x20x2 cm _ 7,8"x7,8"x0,8"	GPR Alsacia, Aran, Pierre, Porfido Tex	12 pz	0,48	22,34	60 bx	28,80	1.355
20x30x1,4 cm _ 7,8"x11,8"x0,6"	GPR Alsacia, Aran, Pierre, Porfido Tex	11 pz	0,66	21,45	64 bx	42,24	1.388
20x30x2 cm _ 7,8"x11,8"x0,8"	GPR Alsacia, Aran, Pierre, Porfido Tex	8 pz	0,48	22,30	64 bx	30,72	1.442
20x120 cm _ 7,8"x47,2"	R GPR Elegance, Isar, Moneo, Tipuana	7 pz	1,68	34,73	44 bx	73,92	1.543
22,5x22,5 cm _ 8,9"x8,9"	GPR Nara	20 pz	1,00	21,15	64 bx	64,00	1.369
22,5x22,5 cm _ 8,9"x8,9"	GPR Arona, Bella, Carole, Hydra, Izar, Valsain	20 pz	1,00	24,00	64 bx	64,00	1.551
25x150 cm _ 9,8"x59"	R GPR Thasos	4 pz	1,50	35,00	40 bx	60,00	1.415
30x30 cm _ 11,8"x11,8"	R GPR Galdar, Iconic, Pulpis, Renzo, Sinclair, Terrae	14 pz	1,26	22,25	40 bx	50,40	905
30x120 cm _ 11,8"x47,2"	R GPR Boiserie	4 pz	1,44	32,00	30 bx	43,20	975
33x120x1,4 cm _ 11,8"x47,2"	R GPR Step	2 pz	0,79	22,00	40 bx	31,60	895
33,3x33,3 cm _ 11,8"x11,8"	GPR Caliza RLV, Palladio RLV, Taxos RLV	12 pz	1,33	17,42	46 bx	61,18	816
40x60 cm _ 15,7"x23,6"	GPR Avalon RLV, Caliza RLV, Elvas RLV, Juliette RLV, Koral RLV, Naos RLV, Preston RLV, Sinai RLV, Taxos RLV, Tineo RLV	5 pz	1,20	25,14	48 bx	57,60	1.222
60x60 cm _ 23,6"x23,6"	R GPR Balbi, Blesle, Casual, Concept, Galdar, Pulpis, Renzo, Sinclair, Terrae, Travertino	4 pz	1,44	29,60	30 bx	43,20	903
60x60x1,4 cm _ 23,6"x23,6"x0,6"	R GPR Pierre Dot	2 pz	0,73	29,03	30 bx	21,90	886
60x90 cm _ 23,6"x35,4"	GPR Avalon RLV, Caliza RLV, Elvas RLV, Juliette RLV, Koral RLV, Naos RLV, Preston RLV, Sinai RLV, Taxos RLV, Tineo RLV	2 pz	1,08	24,12	40 bx	43,20	980
60x90x2 cm _ 23,6"x35,4"x0,8"	GPR Avalon RLV, Caliza RLV, Koral RLV, Juliette RLV, Taxos RLV	1 pz	0,55	23,85	40 bx	22,00	969
60x120 cm _ 23,6"x47,2"	R GPR Balbi, Casual, Concept, Galdar, Pulpis, Renzo, Sinclair, Travertino	2 pz	1,44	29,58	36 bx	51,84	1.080
60x120x1,4 cm _ 23,6"x47,2"x0,6"	R GPR Balbi, Pierre Dot	2 pz	1,44	48,00	24 bx	34,56	1.167
100x100 cm _ 39,4"x39,4"	R GPR Balbi, Blesle, Galdar, Sinai	2 pz	2,00	44,26	27 bx	54,00	1.210
Multi 1	R GPR Isar	5 pz	1,08	25,27	40 bx	43,20	1.026



COMMITMENT TO QUALITY AND EFFICIENT MANAGEMENT THROUGHOUT THE PRODUCTION PROCESS.

Our production process is certified according to the **UNE EN ISO 9001** standard, which guarantees high-quality levels throughout the entire production, from raw materials to the finished product.

COMPROMISO CON LA CALIDAD Y GESTIÓN EFICIENTE EN TODO EL PROCESO PRODUCTIVO.

Nuestro proceso de producción está certificado según la norma **UNE EN ISO 9001**, que garantiza altos niveles cualitativos en toda la producción, desde las materias primas hasta el producto acabado.



PRODUCTION PROCESSES MINIMIZE ENVIRONMENTAL IMPACT

We maintain our commitment to environmental protection through the international standard **UNE EN ISO 14001** for managing environmental risks associated with the development of our activities.

LOS PROCESOS PRODUCTIVOS MINIMIZAN EL IMPACTO AMBIENTAL

Mantenemos nuestro compromiso con la protección del medio ambiente a través de la norma internacional **UNE EN ISO 14001** para la gestión de los riesgos medioambientales asociados al desarrollo de nuestra actividad.



SOCIAL RESPONSIBILITY IN THE WORKPLACE

Certification of both internal and external labor standards, demonstrating our commitment to evaluate ourselves ethically and assess our suppliers to ensure that all parties involved in our business are fair and socially responsible.

RESPONSABILIDAD SOCIAL EN EL MUNDO LABORAL

Certificación de los estándares de trabajo tanto internos como externos, demostrando así nuestro compromiso para evaluarnos a nivel ético y evaluar a nuestros proveedores para asegurarnos de que todos los agentes involucrados en nuestro negocio son justos y socialmente responsables.

BESTILE reserves the right to cancel or modify, totally or partially, any of the models, colors, formats, references or technical specifications included in this catalog.

The colors shown in this catalog are merely for guidance and may vary from the original piece.

Measurements and references should be verified because there may be typographical errors.

BESTILE se reserva el derecho de anular o modificar, total o parcialmente, cualquiera de los modelos, colores, formatos, referencias y especificaciones técnicas contenidas en este catálogo.

Los colores reproducidos en este catálogo son puramente orientativos y pueden variar con respecto a la pieza original.

Las medidas y referencias deben verificarse ya que puede haber errores tipográficos.



If I am no longer useful, don't throw me away, recycle me!

Si ya no te soy útil, no me tires, recíclame!

BESTILE
Time to Create



BESTILE S.L.

Partida Torreta S/N _ 12110 Alcora (Castellón) _ Spain

Tel: (+34) 964 367 320 _ www.bestile.es

DESIGN AND LAYOUT - DISEÑO Y MAQUETACIÓN

Bestile Marketing - Marketing Bestile

Printing - Impresión - V1

Mayo 2026 - May 2026